

# ITT

**BGPBRUIS**

## Residential Water Systems

# Goulds Pumps **BRUISER**<sup>®</sup>

5SB, 7SB, 10SB & 18SB  
5-18 GPM, 1/2 – 1 1/2 HP,  
60 Hz Submersible Pumps



Goulds Pumps is a brand of ITT Corporation.

[www.goulds.com](http://www.goulds.com)

*Engineered for life*

## FEATURES

- **Abrasive Handling Construction:** Impellers designed with flat wearing surface which provides effective sand handling capabilities.
- **Field Serviceable:** Pump can be rebuilt in the field to like new condition with common tools and readily available spare parts. **NOTE:** The pump has left hand casing threads.
- **Powered for Continuous Operation:** All ratings are within the working limits of the motor as recommended by the motor manufacturer. Pump can be operated continuously without damage to the motor.
- **Metal Parts are Stainless Steel:** AISI types 301 and 304 are corrosion resistant, non-toxic and non-leaching.
- **Non-Metallic Parts are FDA Compliant:** Impellers, diffusers and bearing spiders are constructed of a glass filled, corrosion resistant engineered composite.
- **Discharge Head:** Engineered composite material for superior strength and corrosion resistance. Loops for safety line molded into head.
- **Motor Adapter:** Engineered composite material with high rigidity to provide accurate alignment of liquid end to motor. Generous space for removal of motor mounting nuts with regular open-end wrench.
- **Bowls:** Stainless steel for strength and abrasive resistance.
- **Check Valve:** Screws into discharge head from the top, easily removed for drain-back systems or replacement without disassembling the pump. Spring loaded, o-ring poppet design for positive seal in all conditions.
- **Stainless Steel Casing:** Polished stainless steel is strong, attractive and corrosion resistant.
- **Hex Shaft Design:** Six sided shaft for positive impeller drive.
- **Inlet Strainer:** Molded suction strainer built into motor adapter.
- **Engineered Polymer Bearings:** The proprietary, engineered polymer bearing material is extremely strong and highly resistant to abrasion and wear. The enclosed design upper bearing is mounted in a durable Noryl bearing spider for excellent abrasion resistance.

## AGENCY LISTINGS

All composite materials are ANSI/NSF Compliant.

 Canadian Standards Association  ANSI/NSF 61- Drinking Water System Components 4P49

Goulds Pumps is ISO 9001 Registered.

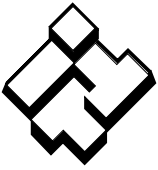

# ITT

## GOULDS PUMPS Residential Water Systems

### WATER END DATA

Series	Model	Required H.P.	Stages	Water End	
				Length (in)	Wt (lbs)
5SB	5SB05	.5	12	15.0	9
	5SB07	.75	15	17.0	11
	5SB10	1	20	21.7	13
7SB	7SB05	.5	10	13.8	7
	7SB07	.75	13	16.0	8
	7SB10	1	17	18.8	9
10SB	10SB05	.5	7	11.5	7
	10SB07	.75	10	13.6	8
	10SB10	1	12	15.0	9
	10SB15	1.5	17	18.4	12
18SB	18SB07	.75	6	11.8	7
	18SB10	1	8	13.5	8
	18SB15	1.5	11	16.1	10

### SPECIFICATIONS

Model	Flow Range GPM	Horsepower Range	Best Eff. GPM	Discharge Connection	Minimum Well Size	Rotation <sup>①</sup>
5SB	1.2 – 7.5	½ – 1	5	1¼	4"	CCW
7SB	1.5 – 10	½ – 1	7	1¼	4"	CCW
10SB	3 – 16	½ – 1½	10	1¼	4"	CCW
18SB	6 – 28	¾ – 1½	18	1¼	4"	CCW

① Rotation is counterclockwise when observed from pump discharge end.

### "SB" SERIES MATERIALS OF CONSTRUCTION

Part Name	Material
Discharge Head	Glass Filled Engineered Composite
Check Valve Poppet	Delrin®
Check Valve O-ring	NBR
Bearing Spider – Upper	Noryl®/GFN2
Bearing	Proprietary Engineered Polymer
Shaft Retaining Ring	AISI 301 SS
Diffuser	Lexan®
Impeller	Noryl®/GFN2
Bowl	AISI 304 SS
Shim	AISI 304 SS
Inlet Strainer	Glass Filled Engineered Composite
Screws – Cable Guard	AISI 304 SS
Motor Adapter	Glass Filled Engineered Composite
Casing	AISI 304 SS
Shaft	
Coupling	AISI 304 SS, Powder Metal
Cable Guard	AISI 304 SS

\*See repair parts for where used.

### NOMENCLATURE

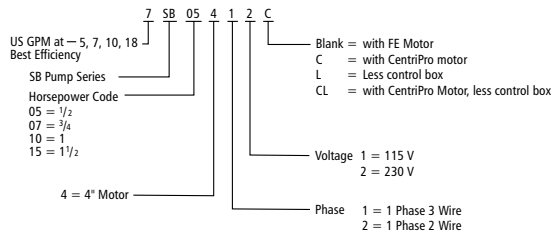

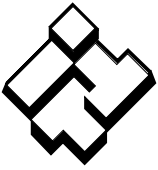

# ITT

## GOULDS PUMPS Residential Water Systems

### CENTRIPRO 4" SINGLE-PHASE MOTORS

Order No.	Type	HP	Volts	Length in. (mm)	Weight lb. (kg.)
M05421	2-wire PSC	.5	115	11.0 (279)	19.2 (8.7)
M05422		.5	230	11.0 (279)	19.2 (8.7)
M07422		.75		12.4 (314)	22.7 (10.3)
M10422		1		13.3 (337)	24.5 (11.1)
M15422		1.5		14.9 (378)	28.9 (13.1)
M05411	3-wire	.5	115	10.0 (253)	18.9 (8.6)
M05412		.5	230	9.7 (246)	18.1 (8.2)
M07412		.75		10.8 (275)	21.4 (9.7)
M10412		1		11.7 (297)	23.1 (10.5)
M15412		1.5		13.6 (13.6)	27.4 (12.4)

### CENTRIPRO 4" THREE-PHASE MOTORS

Order No.	HP	Volts	Length in. (mm)	Weight lb. (kg.)
M10432	1	230	11.7 (297)	23.1 (10.5)
M15432	1.5		11.7 (297)	23.1 (10.5)
M10434	1	460	11.7 (297)	23.1 (10.5)
M15434	1.5		11.7 (297)	23.1 (10.5)

### NEMA MOTOR

- Corrosion resistant stainless steel construction.
- Built-in surge arrestor is provided on single phase motors.
- Stainless steel splined shaft.
- Hermetically sealed windings.
- Replaceable motor lead assembly.
- CSA certified.
- UL 778 recognized.
- NEMA mounting dimensions.
- Control box is required with 3 wire single-phase units.
- Three-phase motors require a starter with Class 10 overload protection.

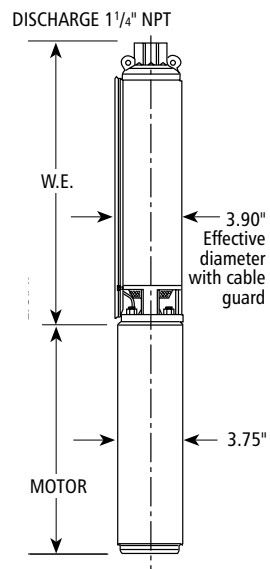

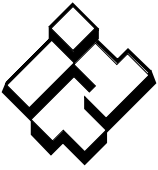

# ITT

## GOULDS PUMPS Residential Water Systems

### Model 5SB

#### SELECTION CHART

Horsepower Range ½ – 1, Recommended Range 1.2 – 7.5 GPM, 60 Hz, 3500 RPM

Pump Model	HP	PSI	Depth to Water in Feet/Ratings in GPM (Gallons per Minute)																								
			20	40	60	80	100	120	140	160	180	200	220	240	260	280	300	340	380	420	460	500	540	580	620		
5SB05	½	0							7.7	7.3	6.9	6.4	6.0	5.6	5.1	4.7	4.1	2.6									
		20					7.5	7.1	6.7	6.3	5.9	5.4	5.0	4.5	3.9	3.2	2.3										
		30				7.5	7.1	6.7	6.2	5.8	5.4	4.9	4.4	3.8	3.1	2.1											
		40			7.4	7.0	6.6	6.2	5.7	5.3	4.9	4.3	3.7	2.9	1.9												
		50	7.7	7.4	6.9	6.5	6.1	5.7	5.2	4.8	4.2	3.6	2.8	1.8													
		60	7.3	6.9	6.5	6.0	5.6	5.2	4.7	4.2	3.5	2.6	1.6														
Shut-off PSI			156	147	138	130	121	112	104	95	86	78	69	60	52	43	34	17									
5SB07	¾	0										7.6	7.3	7.0	6.6	6.3	5.9	5.2	4.4	3.3	1.6						
		20									7.5	7.2	6.9	6.5	6.2	5.8	5.5	5.1	4.2	3.1	1.3						
		30							7.5	7.2	6.8	6.5	6.1	5.8	5.4	5.0	4.6	3.6	2.1								
		40					7.4	7.1	6.8	6.4	6.1	5.7	5.4	5.0	4.6	4.1	2.8										
		50				7.4	7.1	6.7	6.4	6.0	5.7	5.3	4.9	4.5	4.0	3.4	1.8										
		60			7.6	7.3	7.0	6.7	6.3	6.0	5.6	5.3	4.9	4.4	3.9	3.3	2.6										
Shut-off PSI					184	175	167	158	149	141	132	123	115	106	97	89	80	63	45	28	11						
5SB10	1	0														7.5	7.0	6.5	5.9	5.3	4.6	3.8	2.8	1.6			
		20												7.6	7.4	7.2	7.0	6.4	5.9	5.2	4.5	3.7	2.6				
		30											7.6	7.4	7.2	6.9	6.7	6.1	5.5	4.8	4.0	3.1	1.9				
		40										7.6	7.4	7.1	6.9	6.6	6.3	5.8	5.1	4.4	3.5	2.5					
		50									7.5	7.3	7.1	6.8	6.6	6.3	6.0	5.4	4.7	3.9	2.9	1.7					
		60									7.5	7.3	7.1	6.8	6.5	6.3	6.0	5.7	5.0	4.3	3.4	2.3					
Shut-off PSI										214	206	197	188	180	171	162	154	136	119	102	84	67	50	32	15		

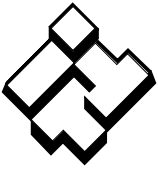

# ITT

## GOULDS PUMPS Residential Water Systems

### Model 7SB

#### SELECTION CHART

Horsepower Range ½ – 1, Recommended Range 1.5 – 10 GPM, 60 Hz, 3450 RPM

Pump Model	HP	PSI	Depth to Water in Feet/Ratings in GPM (Gallons per Minute)																										
			20	40	60	80	100	120	140	160	180	200	220	240	260	280	300	320	340	360	380	400	420	440	460	480	500		
7SB05	½	0								10.1	9.2	8.3	7.4	6.3	5.0	3.4													
		20						9.8	9.0	8.1	7.1	6.0	4.6	2.7															
		30					9.7	8.8	7.9	6.9	5.8	4.3	2.4																
		40			10.4	9.6	8.7	7.8	6.7	5.6	4.1	2.0																	
		50	10.3	9.4	8.5	7.6	6.6	5.4	3.8	1.7																			
		60	10.2	9.3	8.4	7.5	6.4	5.1	3.5																				
Shut-off PSI			125	116	107	99	90	81	73	64	55	47	38	29	21	12													
7SB07	¾	0											10.0	9.3	8.6	7.9	7.1	6.2	5.2	4.0	2.4								
		20								10.4	9.8	9.1	8.4	7.7	6.9	6.0	4.9	3.5	1.8										
		30								10.3	9.7	9.0	8.3	7.5	6.7	5.8	4.7	3.3	1.5										
		40							10.2	9.5	8.9	8.2	7.4	6.6	5.6	4.5	3.1												
		50					10.1	9.4	8.8	8.1	7.3	6.5	5.5	4.3	2.8														
		60				10.0	9.3	8.7	7.9	7.2	6.3	5.3	4.1	2.5															
Shut-off PSI						140	131	122	114	105	96	88	79	70	62	53	44	36	27	18	10								
7SB10	1	0														10.1	9.6	9.0	8.5	7.9	7.3	6.7	6.0	5.3	4.4	3.4	2.1		
		20											10.4	9.9	9.4	8.9	8.3	7.7	7.1	6.5	5.8	5.0	4.1	3.0	1.6				
		30											10.3	9.9	9.3	8.8	8.2	7.6	7.0	6.4	5.7	4.9	4.0	2.8					
		40											10.3	9.8	9.2	8.7	8.1	7.5	6.9	6.3	5.6	4.8	3.8	2.6					
		50									10.2	9.7	9.2	8.6	8.0	7.4	6.8	6.2	5.4	4.6	3.7	2.4							
		60								10.1	9.6	9.1	8.5	7.9	7.3	6.7	6.0	5.3	4.5	3.5	2.2								
Shut-off PSI									166	158	149	140	132	123	114	106	97	88	80	71	62	54	45	36	28	19	10		

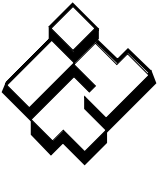

# ITT

## GOULDS PUMPS Residential Water Systems

### Model 10SB

#### SELECTION CHART

Horsepower Range ½ – 1½, Recommended Range 3 – 16 GPM, 60 Hz, 3500 RPM

Pump Model	HP	PSI	Depth to Water in Feet/Ratings in GPM (Gallons per Minute)																					
			20	40	60	80	100	120	140	160	180	200	220	240	260	280	300	340	380	420	460	500	540	
10SB05	½	0				16.0	15.3	14.3	12.8	11.3	9.0	6.4												
		20		15.9	14.9	13.8	12.5	10.8	8.3	4.8														
		30	15.7	14.6	13.5	12.3	10.5	7.8	4.0															
		40	14.5	13.4	12.0	10.3	7.5	3.0																
		50	13.0	11.5	9.8	7.2																		
		60	11.3	9.0	6.4																			
Shut-off PSI		89	81	72	63	55	46	37	29	20	11													
10SB07	¾	0					16.0	15.2	14.3	13.4	12.5	11.5	10.3	9.0	7.0	4.0								
		20				15.8	15.0	14.0	13.0	12.3	11.2	10.2	8.5	6.0										
		30			15.7	14.8	13.9	12.8	12.0	11.0	9.8	8.2	5.5											
		40		15.6	14.7	13.8	12.7	11.9	10.8	9.7	8.1	5.2												
		50	15.3	14.4	13.5	12.6	11.6	10.5	9.4	7.5	4.8													
		60	14.3	13.4	12.5	11.5	10.3	9.0	7.0	4.0														
Shut-off PSI		130	121	113	104	95	87	78	69	61	52	43	35	26	17	9								
10SB10	1	0							15.8	15.2	14.5	13.7	12.8	12.0	11.0	10.0	6.7							
		20					15.7	14.9	14.3	13.5	12.7	11.7	10.6	9.6	8.1	6.5								
		30				16.0	15.6	14.8	14.2	13.3	12.5	11.6	10.4	9.4	7.8	5.5	3.0							
		40			16.0	15.5	14.7	14.1	13.2	12.4	11.5	10.3	9.1	7.4	5.0	3.0								
		50			15.3	14.6	13.9	13.0	12.3	11.3	10.1	8.9	7.0	4.3										
		60	15.8	15.2	14.5	13.7	12.8	12.0	11.0	10.0	8.6	6.7	4.0											
Shut-off PSI		158	150	141	132	124	115	106	98	89	81	72	63	55	46	37	20							
10SB15	1½	0											15.7	15.3	14.8	14.4	13.3	12.2	10.9	9.3	7.1	3.0		
		20										16.0	15.6	15.2	14.7	14.3	13.7	13.2	11.9	10.6	9.0	6.5		
		30									15.9	15.5	15.2	14.6	14.2	13.5	13.1	12.6	11.3	9.7	7.6	4.0		
		40							15.8	15.5	15.1	14.6	14.2	13.5	13.0	12.5	11.8	10.3	8.8	6.0				
		50						15.7	15.4	14.9	14.5	14.0	13.4	12.8	12.3	11.7	11.0	9.4	7.4	3.4				
		60					15.7	15.3	14.8	14.4	13.9	13.3	12.8	12.2	11.6	10.9	10.1	8.1	5.6					
Shut-off PSI					197	188	180	171	162	154	144	136	128	119	110	93	76	58	41	24	6			

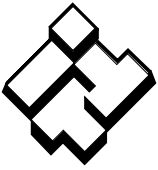

# ITT

**GOULDS PUMPS**  
Residential Water Systems

## Model 18SB

### SELECTION CHART

Horsepower Range  $\frac{3}{4}$  –  $1\frac{1}{2}$ , Recommended Range 6 – 28 GPM, 60 Hz, 3500 RPM

Pump Model	HP	PSI	Depth to Water in Feet/Ratings in GPM (Gallons per Minute)															
			20	40	60	80	100	120	140	160	180	200	220	240	260	280	300	340
18SB07	$\frac{3}{4}$	0			28.2	26.5	24.0	21.0	17.9	13.5								
		20	27.7	25.9	23.0	20.0	16.5	10.8										
		30	25.0	22.0	18.8	15.7	9.5											
		40	22.2	18.9	15.1	9.0												
		50	18.4	15.0	7.5													
		60	13.5	5.0														
<b>Shut-off PSI</b>			74	66	58	49	40	32	23	14								
18SB10	1	0					27.0	25.5	23.6	21.2	18.8	15.9	12.0					
		20		28.0	26.6	25.1	22.7	20.0	17.6	14.0	10.0							
		30	27.9	26.1	24.3	22.2	19.8	17.1	13.8	8.3								
		40	26.0	24.1	22.0	19.7	17.0	13.1	8.0									
		50	24.0	22.0	19.1	16.5	13.0	7.1										
		60	21.0	18.6	15.8	12.0												
<b>Shut-off PSI</b>			103	94	86	77	68	60	51	42	34	25	16					
18SB15	$1\frac{1}{2}$	0						28.4	27.2	26.0	24.8	23.0	21.4	19.6	17.5	15.0	12.1	
		20				27.8	26.8	25.4	24.0	22.2	20.6	18.8	16.7	14.0	10.0			
		30			27.7	26.5	25.3	23.8	22.0	20.2	18.5	16.1	13.5	10.0				
		40		27.5	26.3	25.0	23.6	22.0	20.1	18.1	16.0	13.1	9.5					
		50	27.6	26.4	25.0	23.4	21.8	20.0	18.0	15.5	13.0	9.2						
		60	26.0	24.6	23.0	21.2	19.5	17.5	15.0	12.0	7.9							
<b>Shut-off PSI</b>			143	134	126	117	108	100	91	82	74	65	56	48	39	30	22	

# Model 5SB

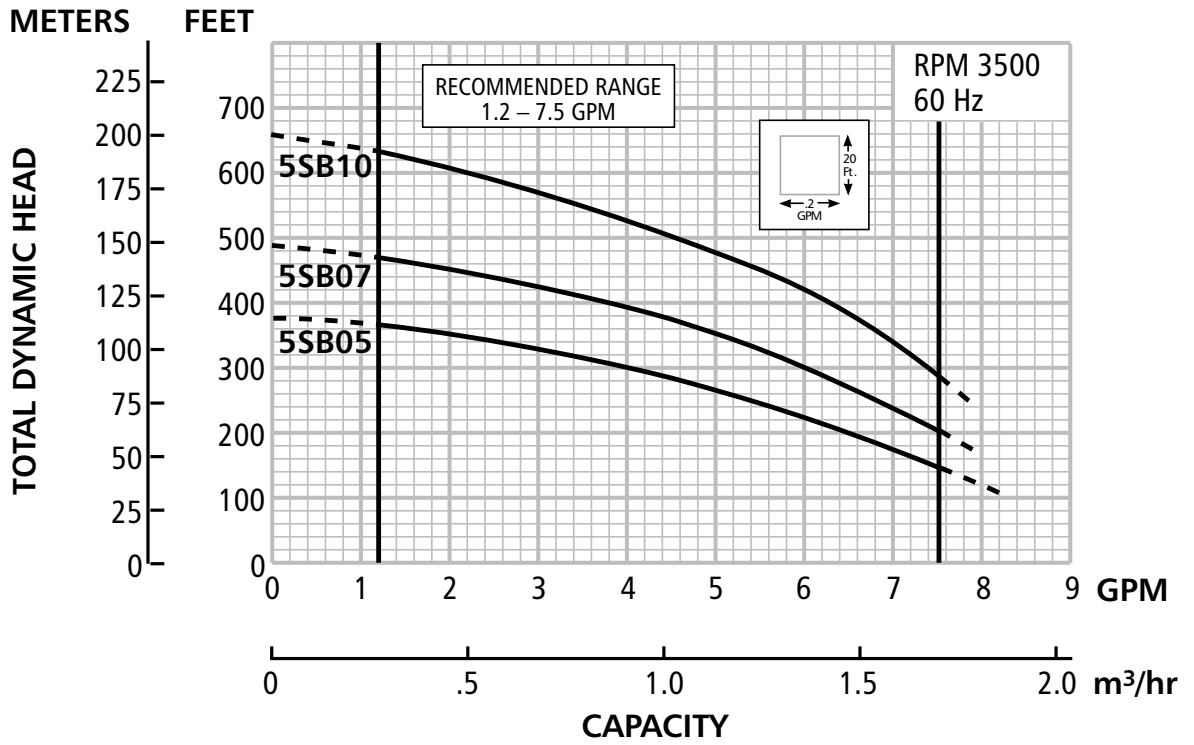

# Model 7SB

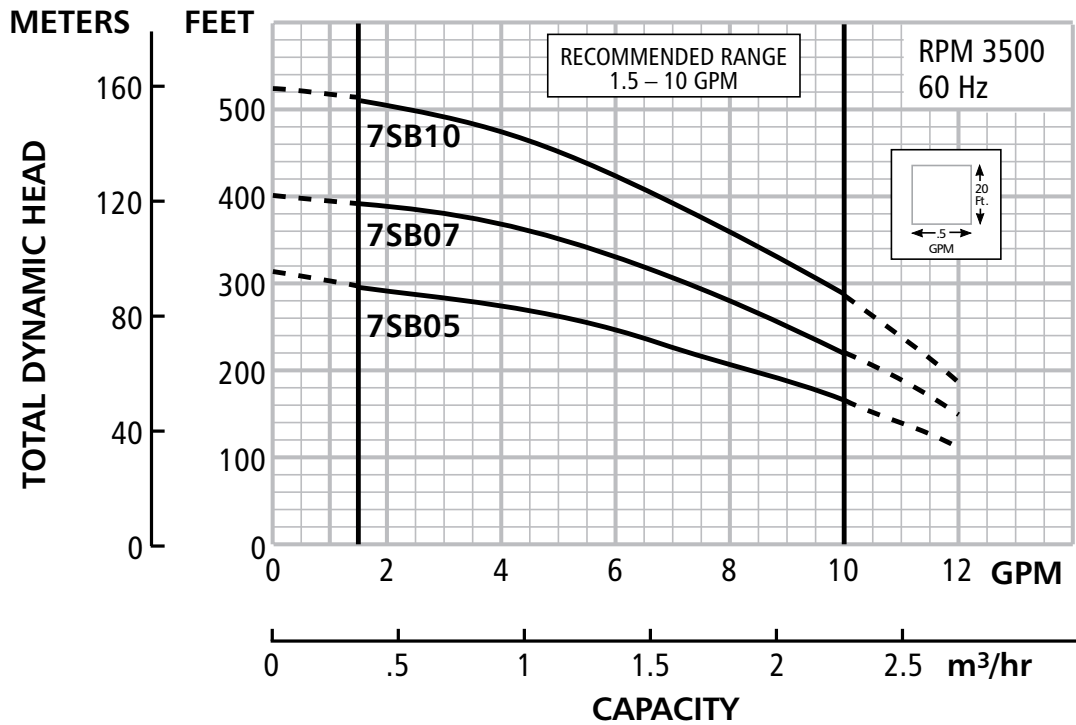



# Model 10SB

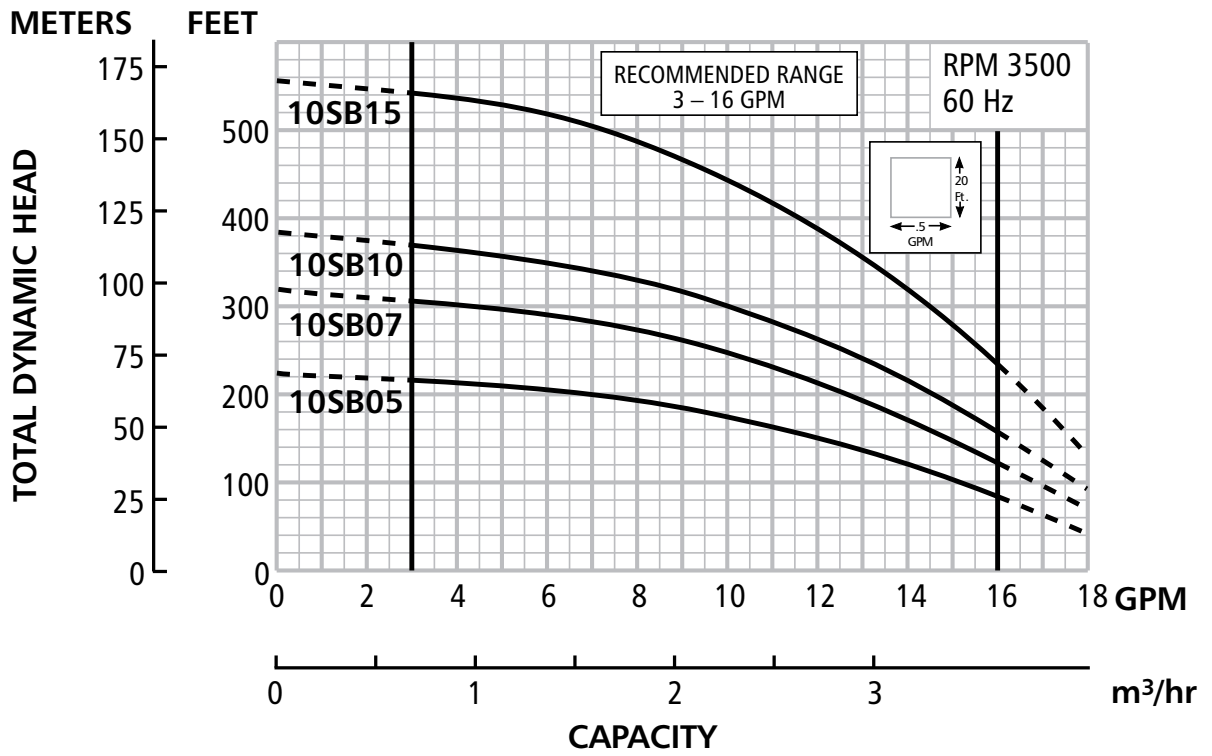

# Model 18SB

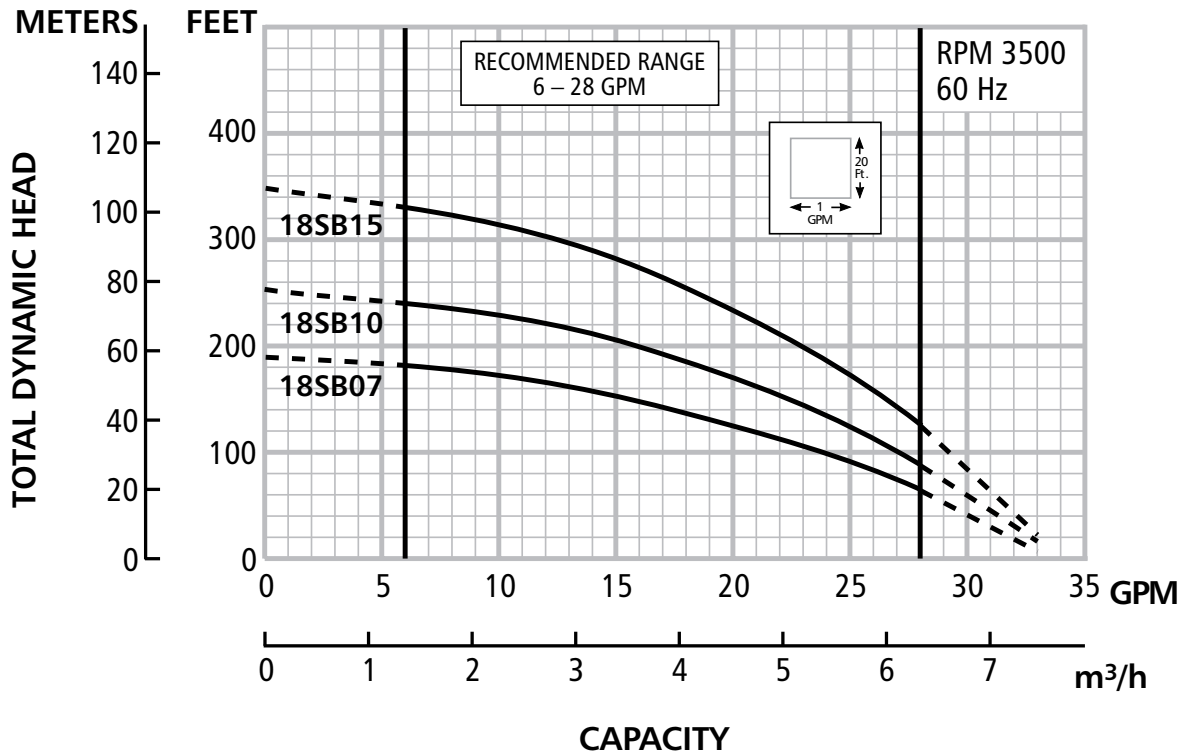

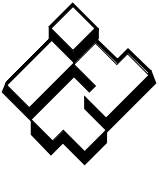

# ITT

## GOULDS PUMPS Residential Water Systems

Repair Parts for SB Series pump built between July 2004 and April 2005 with new screw-in style check valve and new style discharge head identified by 2 safety loops.

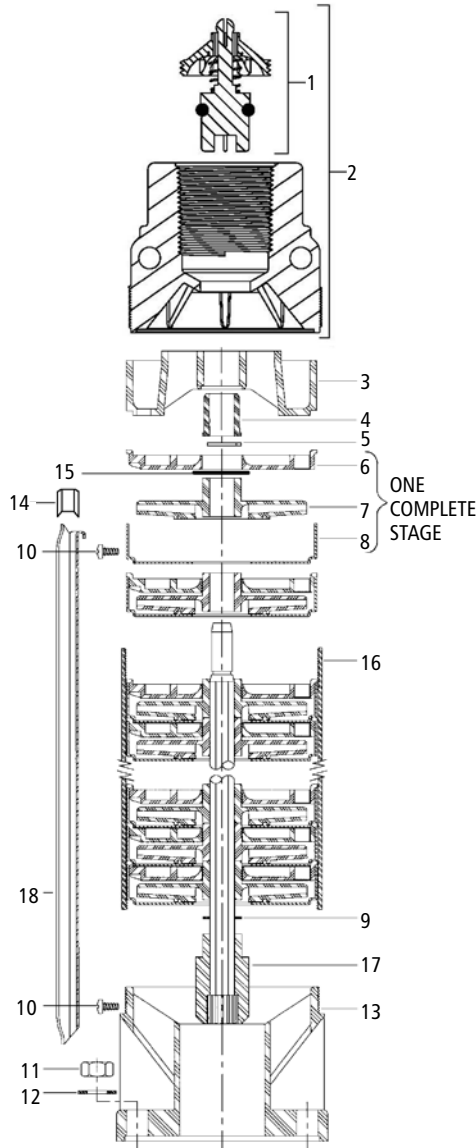

Item No.	Description	Current Models				
		HP	5SB	7SB	10SB	18SB
	NUMBER OF STAGES	1/2	12	10	7	—
		3/4	15	13	10	6
		1	20	17	12	8
		1 1/2	—	—	17	11
1	Check valve assembly		7K2227	7K2227	7K2227	7K2227
2	Discharge head with check valve assembly		7K2077	7K2077	7K2077	7K2077
3	Bearing spider		7K1372	7K1372	7K1372	7K1372
4	Bearing		7K1740	7K1740	7K1740	7K1740
5	Shaft retaining ring		7K817	7K817	7K817	7K817
6	Diffuser		7K1750	7K995B	7K17	7K20
7	Impeller		7K1837	7K1343	7K35	7K1334
8	Bowl		7K1838	7K478	7K478	7K858
9	Shim		7K155	7K155	7K155	7K155
10	Cable guard screws		13K122	13K122	13K122	13K122
11	Hex nuts (quantity 4)		13K114	13K114	13K114	13K114
12	Washers (quantity 4)		7K1565	7K1565	7K1565	7K1565
13	Motor adapter		7K2078	7K2078	7K2078	7K2078
14	Motor lead insulator		7K1023	7K1023	7K1023	7K1023
15	Upthrust washer		7K15	7K15	7K15	7K15
16	Casings	1/2	7K2622	7K2621	7K2617	—
		3/4	7K2625	7K2623	7K2620	7K2618
		1	7K2628	7K2627	7K2622	7K2619
		1 1/2	—	—	7K2626	7K2624
17	Shaft and Coupling (Assemblies)	1/2	7K1377	7K1376	7K1360	—
		3/4	7K1381	7K1380	7K1375	7K1359
		1	7K1458	7K1384	7K1377	7K1375
		1 1/2	—	—	7K1457	7K1380
18	Cable guards	1/2	7K2634	7K2633	7K2629	—
		3/4	7K2637	7K2635	7K2632	7K2630
		1	7K2640	7K2639	7K2634	7K631
		1 1/2	—	—	7K2638	7K2636

**NOTE:** See ROBJETSU for obsolete products for previous version repair parts.

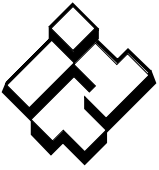

# ITT

## GOULDS PUMPS Residential Water Systems

Repair Parts for SB Series pump built after May 2005 with new screw-in style check valve and new style discharge head identified by 2 safety loops.

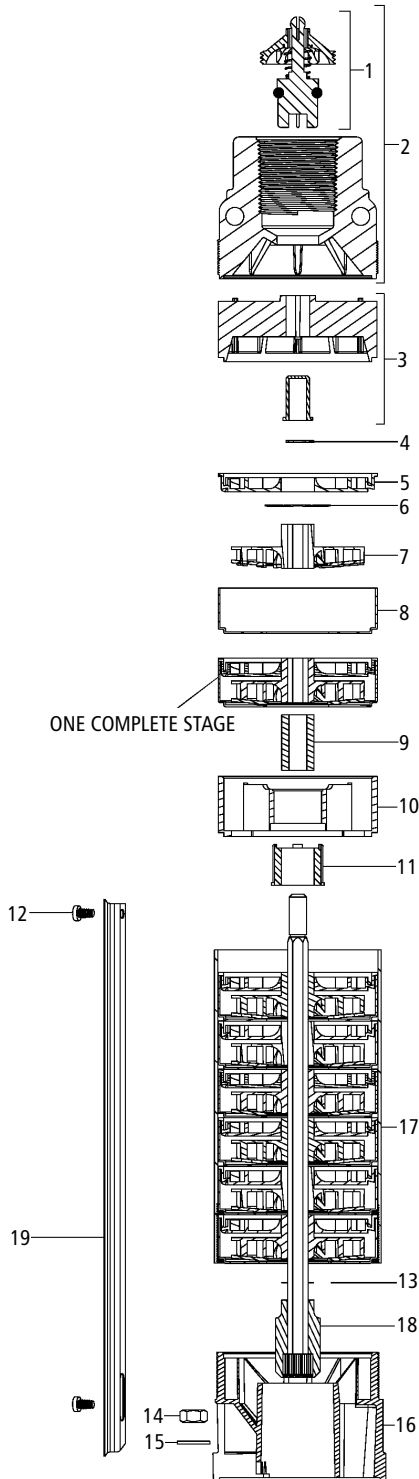

Item No.	Description	Current Models				
		HP	5SB	7SB	10SB	18SB
	NUMBER OF STAGES	1/2	12	10	7	—
		3/4	15	13	10	6
		1	20 <sup>①</sup>	17	12	8
		1 1/2	—	—	17	11
1	Check valve assembly	7K2227	7K2227	7K2227	7K2227	
2	Discharge head with check valve assembly	7K2077	7K2077	7K2077	7K2077	
3	Bearing spider assembly (upper)	7K2676 <sup>②</sup>	7K2676 <sup>②</sup>	7K2676 <sup>②</sup>	7K2676 <sup>②</sup>	
4	Shaft retaining ring	7K817	7K817	7K817	7K817	
5	Diffuser	7K1750	7K995B	7K17	7K20	
6	Upthrust washer	7K15	7K15	7K15	7K15	
7	Impeller	7K1837	7K1343	7K35	7K1334	
8	Bowl	7K1838	7K478	7K478	7K858	
9 <sup>①</sup>	Intermediate shaft sleeve	7K209	—	—	—	
10 <sup>①</sup>	Intermediate bearing spider	7K1371	—	—	—	
11 <sup>①</sup>	Mid bearing	7K2755	—	—	—	
12	Screws – cable guard	13K122	13K122	13K122	13K122	
13	Shim	7K155	7K155	7K155	7K155	
14	Hex nuts (quantity 4)	13K114	13K114	13K114	13K114	
15	Washers (quantity 4)	7K1565	7K1565	7K1565	7K1565	
16	Motor adapter	7K2078	7K2078	7K2078	7K2078	
17	Casings	1/2	7K2786	7K2793	7K2798	—
		3/4	7K2787	7K2794	7K2799	7K2810
		1	7K2789	7K2795	7K2786	7K2812
		1 1/2	—	—	7K2802	7K2814
18	Shaft and Coupling (Assemblies)	1/2	7K1377	7K1376	7K1360	—
		3/4	7K1381	7K1380	7K1375	7K1359
		1	7K2849	7K1384	7K1377	7K1375
		1 1/2	—	—	7K1457	7K1380
19	Cable guards	1/2	7K2763	7K2228	7K1883	—
		3/4	7K2766	7K2229	7K2760	7K1884
		1	7K2770	7K2236	7K2763	7K2760
		1 1/2	—	—	7K2767	7K2229

<sup>①</sup> Indicates models with one intermediate bearing.

<sup>②</sup> Effective May, 2005. upper bearing and spider available as assembly only.

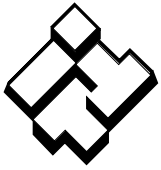

**ITT**

**Residential Water Systems**



Goulds Pumps and the ITT Engineered Blocks Symbol are registered trademarks and tradenames of ITT Corporation. Noryl and Lexan are registered trademarks of GE Plastic. Delrin is a registered trademark of Dupont.

SPECIFICATIONS ARE SUBJECT TO CHANGE WITHOUT NOTICE.

**BGPBRUIS September, 2008**  
Copyright (c) 2008 ITT Corporation

*Engineered for life*