



# ITT

B33-80GS

## Residential Water Systems

# Goulds Pumps

33GS, 40GS, 55GS,  
60GS, 75GS & 80GS

33-80 GPM, 1 – 10 HP,  
60 Hz, Submersible Pumps



 **GOULDS PUMPS**

Goulds Pumps is a brand of ITT Corporation.

[www.goulds.com](http://www.goulds.com)

*Engineered for life*

## FEATURES

- **Powered for Continuous Operation:** All ratings are within the working limits of the motor as recommended by the motor manufacturer. Pump can be operated continuously without damage to the motor.
- **Field Serviceable:** Units have left hand threads and are field serviceable with common tools and readily available repair parts.
- **Sand Handling Design:** Our face clearance, floating impeller stack has proven itself for over 40 years as a superior sand handling, durable pump design.
- **FDA Compliant Non-Metallic Parts:** Impellers, diffusers and bearing spiders are constructed of glass filled engineered composites. They are corrosion resistant and non-toxic.
- **Discharge Head/Check Valve:** Cast 303 stainless steel for strength and durability. Two cast-in safety line loops for installer convenience. The built-in check valve is constructed of stainless steel and FDA compliant BUNA rubber for abrasion resistance and quiet operation.
- **Motor Adapter:** Cast 303 stainless steel for rigid, accurate alignment of pump and motor. Easy access to motor mounting nuts using standard open end wrench.
- **Stainless Steel Casing:** Polished stainless steel is strong and corrosion resistant.
- **Hex Shaft Design:** Six sided shafts for positive impeller drive.
- **Engineered Polymer Bearings:** The proprietary, engineered polymer bearing material is strong and resistant to abrasion and wear. The upper bearing is mounted in a durable engineered composite bearing spider for excellent abrasion resistance.

## WATER END DATA

Series	Model	Required H.P.	Stages	Water End	
				Length (in)	Wt (lbs)
33GS	33GS10	1	6	14.2	8
	33GS15	1.5	8	16.6	9
	33GS20	2	10	19.1	10
	33GS30	3	14	24	13
	33GS50	5	22	35.2	19
	33GS75	7.5	34	50.6	27
	33GS100	10	44	62.8	33
40GS	40GS15	1.5	5	12.9	8
	40GS20	2	6	14.2	8
	40GS30	3	8	16.6	9
	40GS50	5	14	24.0	13
	40GS75	7.5	21	34.0	18
55GS	55GS15	1.5	5	17.1	10
	55GS20	2	7	21.2	12
	55GS30	3	9	25.3	15
	55GS50	5	15	39.1	22
	55GS75	7.5	22	54.1	32
55GS100	10	29	98.4	39	
60GS	60GS15	1.5	4	15.0	8
	60GS20	2	5	17.1	9
	60GS30	3	7	21.2	10
	60GS50	5	11	30.9	14
	60GS75	7.5	17	43.2	19
75GS	75GS30	3	7	24.1	14
	75GS50	5	11	34.8	19
	75GS75	7.5	16	48.2	27
	75GS100	10	21	63.8	35
80GS	80GS30	3	5	21.4	10
	80GS50	5	9	29.4	13
	80GS75	7.5	14	42.8	24

## SPECIFICATIONS

Model	Flow Range GPM	Horse-power Range	Best Efficiency GPM	Discharge Connection	Minimum Well Size	Rotation <sup>①</sup>
33GS	10 – 50	1 – 10	33	2"	4"	CCW
40GS	20 – 65	1½ – 7½	40	2"	4"	CCW
55GS	20 – 80	1½ – 10	55	2"	4"	CCW
60GS	40 – 80	1½ – 7½	60	2"	4"	CCW
75GS	40 – 100	3 – 10	75	2"	4"	CCW
80GS	50 – 120	3 – 7½	80	2"	4"	CCW

① Rotation is counterclockwise when observed from pump discharge end.

## "GS" SERIES MATERIALS OF CONSTRUCTION

Part Name	Material
Discharge Head	AISI 303 SS
Check Valve Poppet	AISI 304 SS
Check Valve Seal	BUNA, FDA compliant
Check Valve Seat	AISI 304 SS
Check Valve Retaining Ring	AISI 302 SS
Bearing Spider – Upper	Glass Filled Engineered Composite
Bearing	Proprietary Engineered Polymer
Klipring	AISI 301 SS
Diffuser	Lexan®
Impeller	Noryl®
Bowl	AISI 304 SS
Intermediate Sleeve*	AISI 304 SS, Powder Metal
Intermediate Shaft Coupling*	AISI 304 SS, Powder Metal
Intermediate Bearing Spider*	Glass Filled Engineered Composite
Intermediate Bearing Spider*	AISI 303 SS
Shim	AISI 304 SS
Screws – Cable Guard	AISI 304 SS
Motor Adapter	AISI 303 SS
Casing	AISI 304 SS
Shaft	AISI 304 SS, 1-3 HP; 17/4 PH, 5-10 HP
Coupling	AISI 304 SS, Powder Metal
Cable Guard	AISI 304 SS
Suction Screen	AISI 304 SS

\*See repair parts for where used.

## NOMENCLATURE – SOLD AS WATER ENDS ONLY

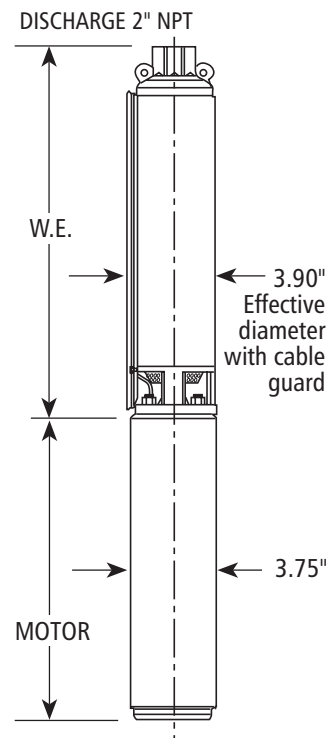
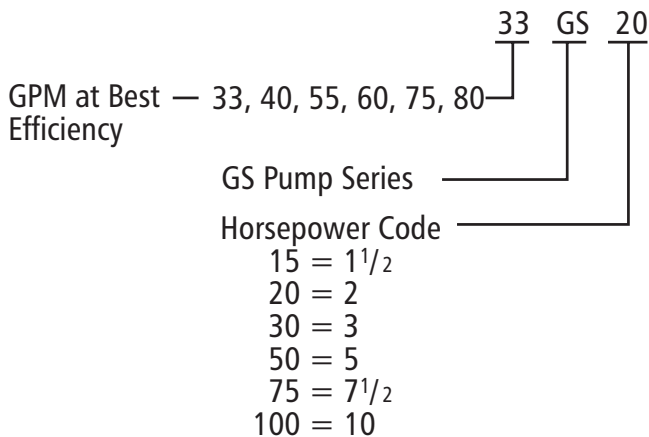

## CENTRIPRO 4" SINGLE-PHASE MOTORS

Order No.	Type	HP	Volts	Length in. (mm)	Weight lb. (kg.)
M10422	2-wire	1	230	13.3 (337)	24.5 (11.1)
M15422	PSC	1.5		14.9 (378)	28.9 (13.1)
M10412	3-wire	1	230	11.7 (297)	23.1 (10.5)
M15412		1.5		13.6 (345)	27.4 (12.4)
M20412		2		15.1 (383)	31.0 (14.1)
M30412		3		18.3 (466)	40.0 (18.1)
M50412		5		27.7 (703)	70.0 (31.8)

## CENTRIPRO 4" THREE-PHASE MOTORS

Order No.	HP	Volts	Length in. (mm)	Weight lb. (kg.)
M10430	1	200	11.7 (297)	22 (10.4)
M15430	1.5		11.7 (297)	22 (10.4)
M20430	2		13.8 (351)	28 (12.7)
M30430	3		15.3 (389)	32 (14.5)
M50430	5		21.7 (550)	55 (24.9)
M75430	7.5		27.7 (703)	70 (31.8)
M10432	1	230	11.7 (297)	23 (10.4)
M15432	1.5		11.7 (297)	23 (10.4)
M20432	2		13.8 (351)	28 (12.7)
M30432	3		15.3 (389)	32 (14.5)
M50432	5		21.7 (550)	55 (24.9)
M75432	7.5		27.7 (703)	70 (31.8)
M10434	1	460	11.7 (297)	23 (10.4)
M15434	1.5		11.7 (297)	23 (10.4)
M20434	2		13.8 (351)	28 (12.7)
M30434	3		15.3 (389)	32 (14.5)
M50434	5		21.7 (550)	55 (24.9)
M75434	7.5		27.7 (703)	70 (31.8)
M15434	1.5	575	11.7 (297)	23 (10.4)
M20434	2		15.3 (389)	32 (14.5)
M30434	3		15.3 (389)	32 (14.5)
M50434	5		27.7 (703)	70 (31.8)
M75434	7.5		27.7 (703)	70 (31.8)

## NEMA MOTOR

- Corrosion resistant stainless steel construction.
- Built-in surge arrestor is provided on single phase motors through 5 HP.
- Stainless steel splined shaft.
- Hermetically sealed windings.
- Replaceable motor lead assembly.
- CSA certified.
- UL 778 recognized.
- NEMA mounting dimensions.
- Control box is required with 3 wire single phase units.
- Three phase motors require a magnetic starter with Class 10 overload protection.

## AGENCY LISTINGS

All factory assembled, complete pump/motor assemblies are UL778 and CSA listed. All pumps and motors comply with ANSI/NSF 61-1992. Motors are UL778 recognized.



Canadian Standards Association



Underwriters Laboratories



ANSI/NSF 61 - Drinking Water System Components 4P49

Goulds Pumps is ISO 9001 Registered.

# Model 33GS

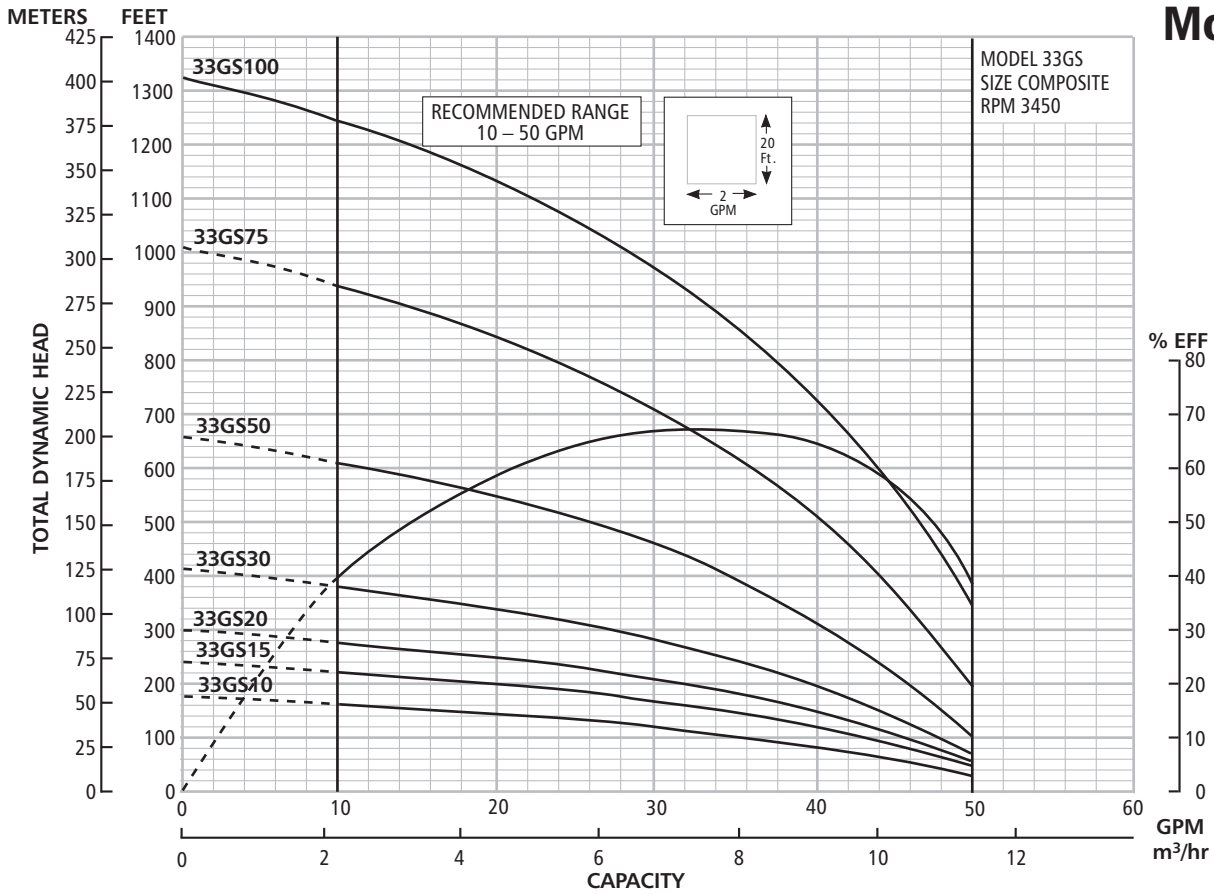

# Model 40GS

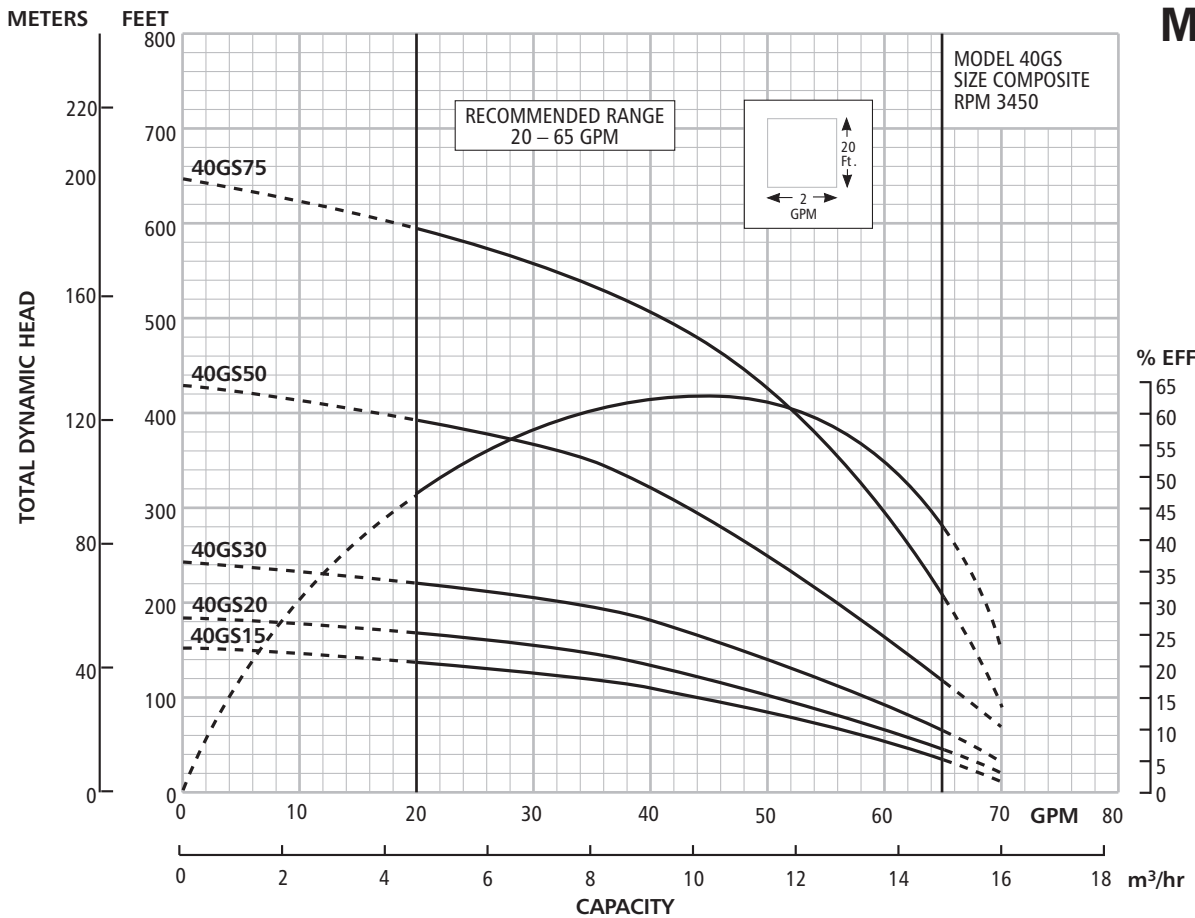

# Model 33GS

## SELECTION CHART

Horsepower Range 1 – 3, Recommended Range 10 – 50 GPM, 60 Hz, 3450 RPM

Pump Model	HP	PSI	Depth to Water in Feet/Ratings in GPM (Gallons per Minute)																											
			20	40	60	80	100	120	140	160	180	200	220	240	260	280	300	320	340	360	380	400	420	440	460	480	520	560	600	
33GS10	1	0		48	45	41	36	30	22	11																				
		20	44	39	34	28	19																							
		30	39	33	27	17																								
		40	32	25	15																									
		50	24	14																										
		60	12																											
Shut-off PSI			67	58	50	41	32	24	15	6																				
33GS15	1½	0		50	48	46	43	40	37	32	26	19																		
		20	48	45	43	39	35	31	24	17																				
		30	45	42	39	35	30	23	15																					
		40	42	38	34	29	22	14																						
		50	38	33	28	21	12																							
		60	33	27	20	11																								
Shut-off PSI			95	86	78	69	60	52	43	34	26	17																		
33GS20	2	0			49	48	46	44	41	38	35	32	28	22																
		20	49	47	45	43	40	38	34	31	26	21	14																	
		30	47	45	42	40	37	34	30	25	20	13																		
		40	44	42	40	37	33	29	24	19	11																			
		50	42	39	36	33	29	24	18																					
		60	39	36	32	28	23	16																						
Shut-off PSI			121	112	103	95	86	77	69	60	51	43	34	26																
33GS30	3	0				49	48	46	45	43	41	40	38	35	33	31	28	24	20	15										
		20	50	49	47	46	44	43	41	39	37	35	32	30	27	23	19	13												
		30	49	47	46	44	42	41	39	37	34	32	29	26	22	18	12													
		40	47	45	44	42	40	38	36	34	32	29	25	22	17	11														
		50	45	44	42	40	38	36	34	31	28	25	21	16																
		60	43	42	40	38	36	33	31	28	24	20	15																	
Shut-off PSI			170	161	152	144	135	126	118	109	100	92	83	74	66	57	48	40	31	23										

Horsepower Range 5-10, Recommended Range 10 – 50 GPM, 60 Hz, 3450 RPM

Pump Model	HP	PSI	Depth to Water in Feet/Ratings in GPM (Gallons per Minute)																											
			50	100	150	200	250	300	350	400	450	500	550	600	650	700	750	800	850	900	950	1000	1050	1100	1150	1200	1250	1300	1350	
33GS50	5	0		50	48	46	44	41	38	35	31	27	20	11																
		20	50	48	46	44	41	38	35	32	27	21	11																	
		30	49	47	45	43	40	37	34	30	25	17																		
		40	48	46	44	41	39	36	32	27	21	12																		
		50	47	45	43	40	37	34	30	25	18																			
		60	46	44	42	39	36	32	28	22	13																			
Shut-off PSI			264	242	220	199	177	156	134	112	91	69	47	26																
33GS75	7½	0				50	48	47	46	44	42	40	38	36	33	31	27	23	19	14										
		20			50	49	47	46	44	42	41	38	36	34	31	28	24	19	14											
		30		50	49	48	46	45	43	42	40	37	35	32	29	26	22	17	12											
		40		50	49	47	46	44	43	41	39	36	34	31	28	24	20	15												
		50		49	48	47	45	43	42	40	38	35	33	30	26	22	17	12												
		60	50	49	47	46	44	43	41	39	37	34	31	28	24	20	15													
Shut-off PSI			415	393	371	350	328	306	285	263	241	220	198	176	155	133	111	90	68	47										
33GS100	10	0							49	48	46	45	43	42	41	40	39	38	36	34	31	28	25	22	18	13				
		20							50	48	46	45	43	42	41	40	39	38	36	34	31	29	25	22	18	14				
		30							49	47	45	44	43	42	41	40	38	37	35	33	30	27	24	20	16	12				
		40							50	48	46	45	44	43	42	40	39	38	36	34	32	29	26	22	18	14				
		50							49	47	45	44	43	42	41	40	39	37	35	33	30	27	24	20	16	12				
		60							50	48	46	45	44	43	42	41	39	38	36	34	32	29	26	22	19	14				
Shut-off PSI			551	529	508	486	464	443	421	399	378	356	334	313	291	269	248	226	205	183	161	140	118	96	75	53				

# Model 40GS

## SELECTION CHART

Horsepower Range 1½ – 7½, Recommended Range 20 – 65 GPM, 60 Hz, 3450 RPM

Pump Model	HP	PSI	Depth to Water in Feet/Ratings in GPM (Gallons per Minute)																											
			20	40	60	80	100	120	140	160	180	200	220	240	260	280	300	320	340	360	380	400	440	480	520	560	600	640		
40GS15	1½	0		65	59	53	46	35																						
		20	58	51	43	31																								
		30	50	41	28																									
		40	40	25																										
		50	22																											
		60																												
Shut-off PSI			57	49	40	31	23	14																						
40GS20	2	0			63	58	53	47	38	25																				
		20	61	57	51	44	35																							
		30	56	50	43	33																								
		40	49	42	31																									
		50	40	29																										
		60	26																											
Shut-off PSI			71	62	53	45	36	27	19	10																				
40GS30	3	0				63	59	56	51	47	41	33	20																	
		20	65	62	58	54	50	45	38	32	30																			
		30	61	58	54	49	44	37	28																					
		40	57	53	48	43	36	26																						
		50	52	48	42	35	24																							
		60	47	41	33	21																								
Shut-off PSI			97	88	80	71	62	54	45	36	28	19	10																	
40GS50	5	0						65	64	62	60	58	56	53	51	48	45	42	38	33	26									
		20				65	63	61	59	57	55	52	50	47	44	41	36	31	23											
		30			64	63	61	59	57	54	52	49	46	43	39	35	29	20												
		40		64	62	60	58	56	54	52	49	46	43	39	35	29	20													
		50	64	62	60	58	56	54	51	49	46	43	39	34	28															
		60	62	60	58	56	53	51	48	45	42	38	33	26																
Shut-off PSI			178	169	161	152	143	135	126	117	109	100	91	83	74	65	57	48	39	31	22									
40GS75	7½	0										65	64	63	62	61	60	59	57	56	54	53	49	44	38	30				
		20										65	64	63	62	61	59	58	57	55	54	52	50	48	43	37	28			
		30									65	64	63	62	61	59	58	57	55	53	52	50	48	45	42	36	27			
		40								65	64	63	62	60	59	58	56	55	53	51	49	47	45	42	39	31	20			
		50						65	64	62	61	60	59	58	56	55	53	51	50	47	45	42	39	31	20					
		60			65	64	63	62	61	60	59	57	56	54	53	51	49	47	44	41	38	35	25							
Shut-off PSI			271	263	254	245	237	228	219	211	202	194	185	176	168	159	150	142	133	124	116	107	90	72	55	38				

# Model 55GS

## SELECTION CHART

Horsepower Range 1½ – 5, Recommended Range 20 – 80 GPM, 60 Hz, 3450 RPM

Pump Model	HP	PSI	Depth to Water in Feet/Ratings in GPM (Gallons per Minute)																									
			20	40	60	80	100	120	140	160	180	200	220	240	260	280	300	320	340	360	380	400	420	440	460	480	500	
55GS15	1½	0	78	71	64	54	42	24																				
		20	61	51	37																							
		30	49	35																								
		40	32																									
		50																										
		60																										
Shut-off PSI			52	43	35	26	17	9																				
55GS20	2	0		76	71	65	58	50	41	28																		
		20	69	63	56	48	37	24																				
		30	62	55	46	35	21																					
		40	54	45	34																							
		50	43	32																								
		60	29																									
Shut-off PSI			76	67	58	50	41	32	24	15																		
55GS30	3	0		80	76	72	68	63	58	52	44	35																
		20	75	71	67	62	56	49	42	32																		
		30	70	66	61	55	48	40	30																			
		40	65	60	54	47	39	28																				
		50	59	53	46	37	26																					
		60	52	45	36	25																						
Shut-off PSI			102	94	85	76	68	59	50	42	33	24																
55GS50	5	0				80	78	76	73	71	68	65	62	58	55	50	46	40	34	27								
		20		80	77	75	73	70	67	64	61	57	53	49	44	39	32	25										
		30	79	77	75	72	70	67	64	60	57	53	48	43	38	31	24											
		40	77	74	72	69	66	63	60	56	52	47	42	37	30	23												
		50	74	71	69	66	63	59	55	51	47	42	36	29	22													
		60	71	68	65	62	59	55	51	46	41	35	28	20														
Shut-off PSI			178	169	161	152	143	135	126	117	109	100	91	83	74	65	57	48	39	31								

Horsepower Range 7½ – 10, Recommended Range 20 – 80 GPM, 60 Hz, 3450 RPM

Pump Model	HP	PSI	Depth to Water in Feet/Ratings in GPM (Gallons per Minute)																									
			20	60	100	140	180	220	260	300	340	380	420	460	500	540	580	620	660	700	740	780	820	860	900	940	980	
55GS75	7½	0			79	76	73	70	66	62	58	52	46	39	31	22												
		20		78	76	73	69	66	61	57	52	45	38	30	20													
		30	80	77	74	71	67	63	59	54	48	41	33	24														
		40	78	75	72	69	65	61	56	51	44	37	28															
		50	76	73	70	67	63	58	53	47	40	32	23															
		60	75	72	68	64	60	55	50	43	36	27																
Shut-off PSI			261	243	226	209	191	174	157	139	122	105	88	70	53	36												
55GS100	10	0			80	78	76	75	73	71	68	66	63	60	56	51	47	41	35	28								
		20		80	78	76	74	73	70	68	65	62	59	55	51	46	40	33	26									
		30		79	77	75	73	71	69	67	64	61	57	53	48	42	36	29	22									
		40	79	78	76	74	72	70	68	65	62	59	55	50	45	39	32	25										
		50	78	77	75	73	71	69	66	63	60	56	52	47	42	35	28	21										
		60	77	76	74	72	70	67	65	61	58	54	49	44	38	31	24											
Shut-off PSI			353	336	319	301	284	267	250	232	215	198	180	163	146	128	111	94	76	59								

METERS FEET

# Model 55GS

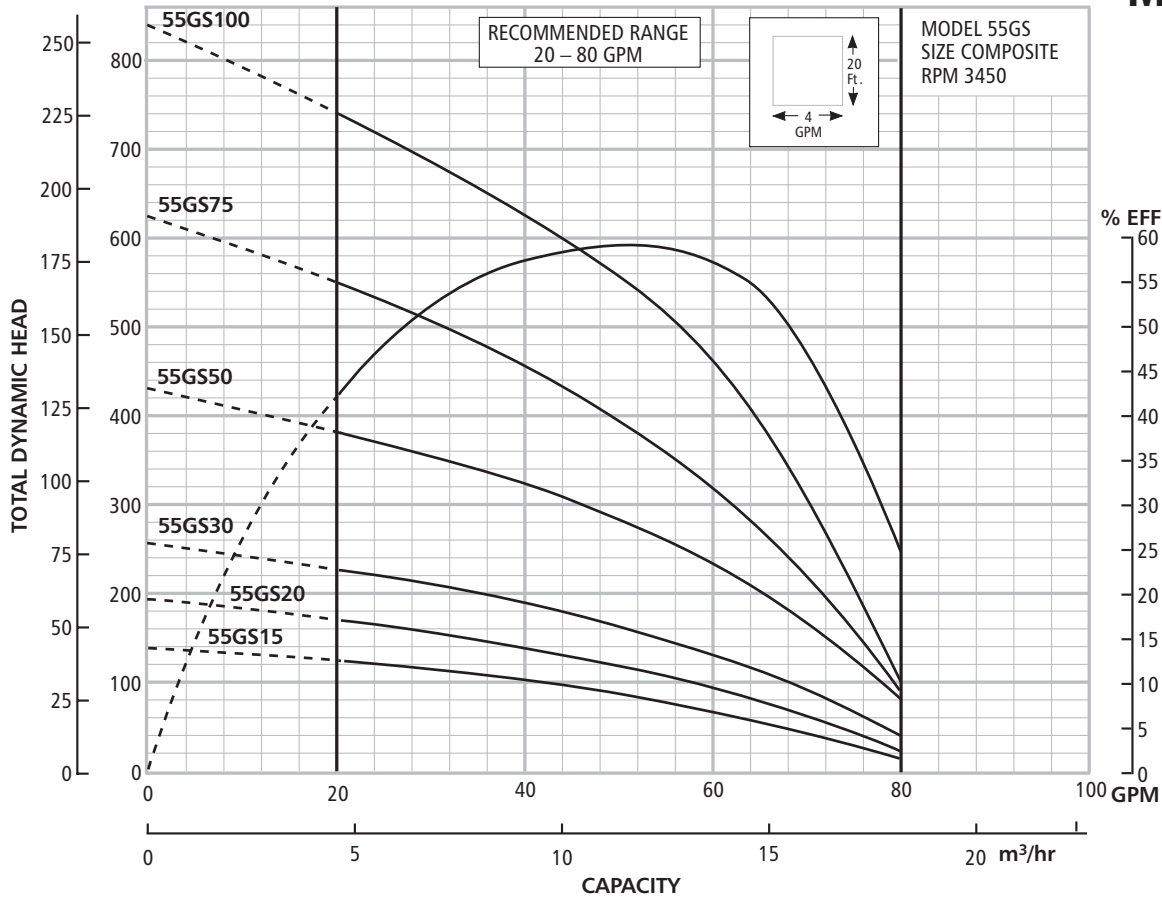

METERS FEET

# Model 60GS

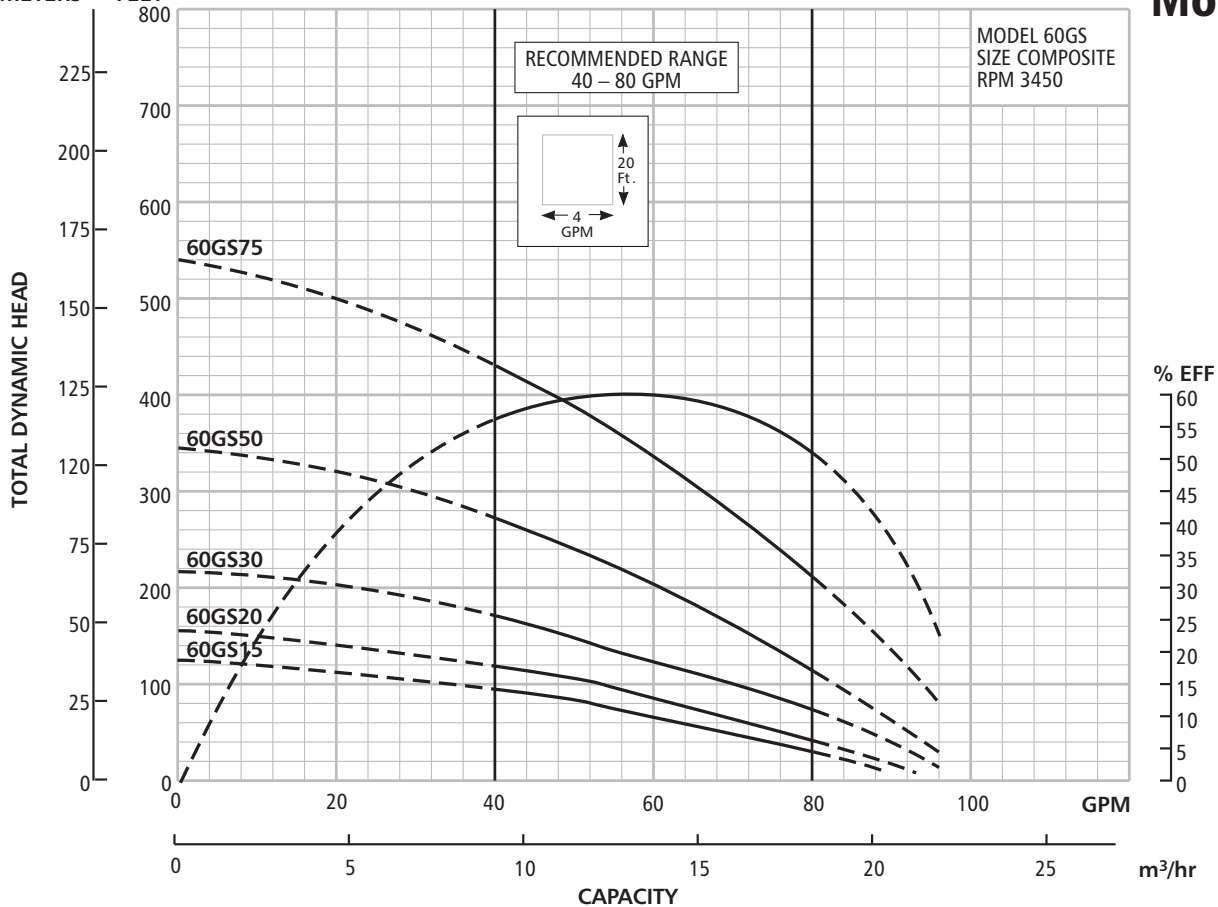



# Model 60GS

## SELECTION CHART

Horsepower Range 1½ – 7½, Recommended Range 40 – 80 GPM, 60 Hz, 3450 RPM

Pump Model	HP	PSI	Depth to Water in Feet/Ratings in GPM (Gallons per Minute)																							
			20	40	60	80	100	120	140	160	180	200	220	240	260	280	300	320	340	360	380	400	420	440	460	480
60GS15	1½	0		75	64	51																				
		20	60	47																						
		30	44																							
		40																								
		50																								
		60																								
Shut-off PSI			45	36	28	19																				
60GS20	2	0			73	63	52																			
		20	70	60	48																					
		30	58	46																						
		40	44																							
		50																								
		60																								
Shut-off PSI			58	50	41	32	24	15	6																	
60GS30	3	0				77	70	62	54	45																
		20		74	67	59	51	42																		
		30	73	66	58	50	40																			
		40	65	57	48																					
		50	56	47																						
		60	45																							
Shut-off PSI			86	77	68	60	51	42	34	25																
60GS50	5	0							75	70	65	60	55	49	43											
		20					73	69	64	59	53	47	41													
		30				73	68	63	58	52	47	40														
		40		76	72	67	62	57	52	46	39															
		50	76	71	66	62	56	51	45	38																
		60	70	66	61	55	50	44																		
Shut-off PSI			140	131	123	114	105	97	88	79	71	62	53	45	36											
60GS75	7½	0										78	75	72	69	66	62	59	55	51	47	42				
		20								80	77	74	71	68	65	61	58	54	50	46	41					
		30								80	77	74	71	68	64	61	57	53	49	45	40					
		40							79	76	73	70	67	64	60	56	52	48	44	40						
		50					79	76	73	70	67	63	60	56	52	48	43									
		60				78	76	73	69	66	63	59	55	51	47	43										
Shut-off PSI			224	215	207	198	189	181	172	163	155	146	137	129	120	111	103	94	85	77	68	59	51			

# Model 75GS

## SELECTION CHART

Horsepower Range 3 – 10, Recommended Range 40 – 100 GPM, 60 Hz, 3450 RPM

Pump Model	HP	PSI	Depth to Water in Feet/Ratings in GPM (Gallons per Minute)																										
			20	40	60	80	100	120	140	160	180	200	220	240	260	280	300	320	340	360	380	400	420	440	460	480	500	520	
75GS30	3	0					80	67	52																				
		20			77	63	47																						
		30		75	61	45																							
		40	73	58	42																								
		50	56	39																									
		60	37																										
Shut-off PSI			77	69	60	51	43	34	25																				
75GS50	5	0							90	83	75	65	55	44															
		20							80	72	62	51	41																
		30						79	70	60	50																		
		40				78	69	59	48																				
		50			77	67	57	47																					
		60		75	66	55	45																						
Shut-off PSI			120	111	102	94	85	76	68	59	50	42	33																
75GS75	7½	0													80	75	68	61	54	47	40								
		20												79	73	66	59	52	45										
		30												78	72	65	58	51	44										
		40												77	71	64	57	50	43										
		50												76	70	63	56	49	42										
		60												75	69	62	55	48	41										
Shut-off PSI										146	137	129	120	111	103	94	85	77	68	59	51	42							
75GS100	10	0													100	97	95	92	88	85	81	76	72	67	62	56	51	45	40
		20													99	96	94	91	87	84	79	75	70	65	60	55	49	44	
		30													99	96	94	91	87	83	79	74	69	64	59	54	48	43	
		40													98	96	93	90	86	82	78	74	69	64	58	53	48	42	
		50													98	95	92	89	86	82	77	73	68	63	57	52	47	41	
		60													100	97	95	92	89	85	81	77	72	67	62	57	51	46	40
Shut-off PSI			272	263	254	246	237	228	220	211	202	194	185	176	168	159	150	142	133	124	116	107	98	90	81	72	64	55	

# Model 80GS

## SELECTION CHART

Horsepower Range 3 – 7½, Recommended Range 50 – 120 GPM, 60 Hz, 3450 RPM

Pump Model	HP	PSI	Depth to Water in Feet/Ratings in GPM (Gallons per Minute)																										
			20	40	60	80	100	120	140	160	180	200	220	240	260	280	300	320	340	360	380	400	420	440	460	480			
80GS30	3	0		114	100	82	63																						
		20	94	77	57																								
		30	74	53																									
		40	50																										
		50																											
		60																											
Shut-off PSI			55	46	38	29	20																						
80GS50	5	0				115	106	98	89	79	68	55																	
		20	120	112	104	95	86	75	64	51																			
		30	111	102	94	84	74	62																					
		40	101	92	83	72	60																						
		50	91	81	70	58																							
		60	79	69	56																								
Shut-off PSI			107	98	90	81	72	64	55	46	38	29																	
80GS75	7½	0						118	113	107	101	95	89	82	75	68	60												
		20				122	117	111	105	100	93	87	80	73	66														
		30			121	116	110	105	99	92	86	79	72	65															
		40	120	115	109	104	98	91	85	78	71	63																	
		50	114	109	103	97	90	84	77	70	62																		
		60	108	102	96	89	83	76	69	61																			
Shut-off PSI			171	162	153	145	136	127	119	110	101	93	84	75	67	58	49												

# Model 75GS

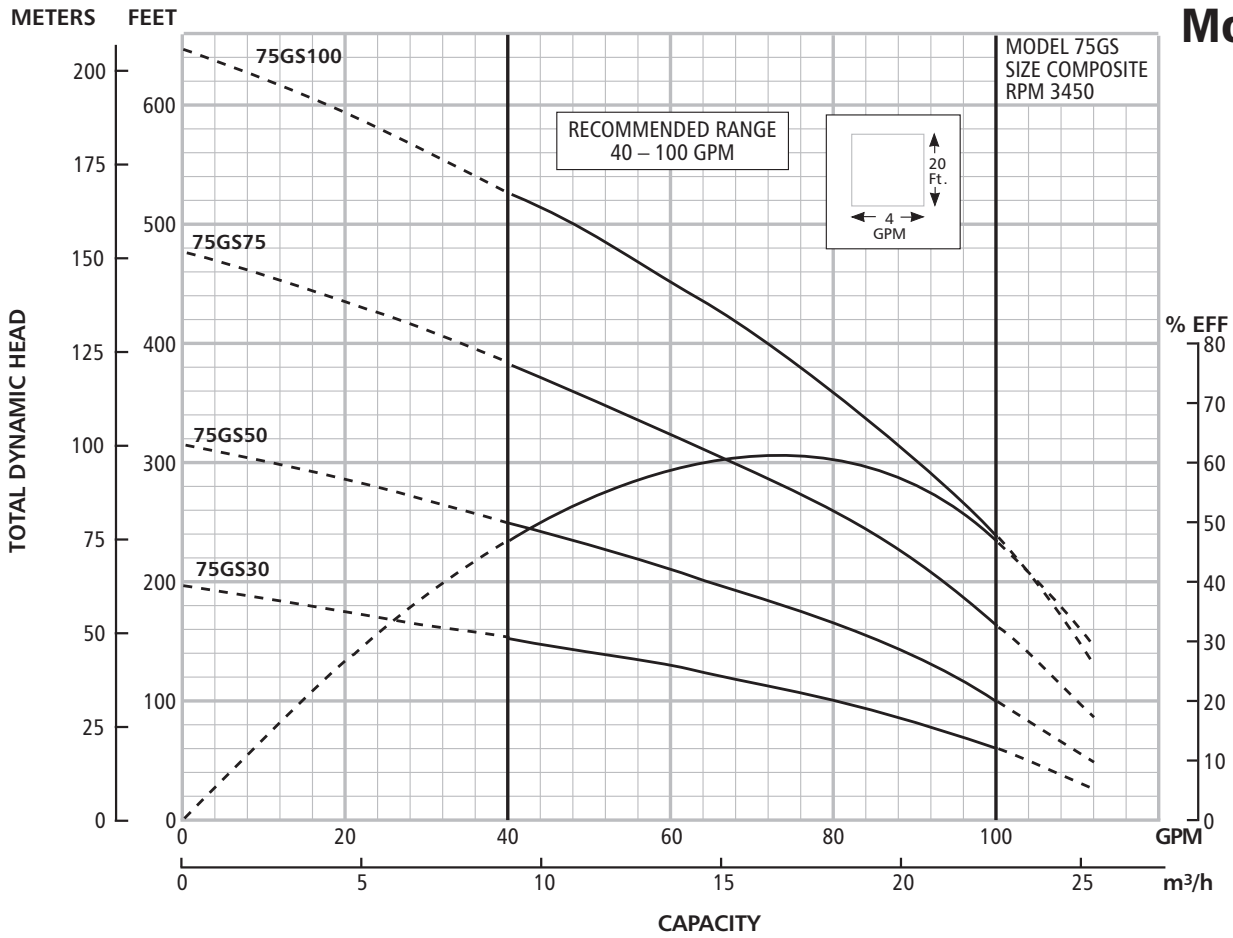

# Model 80GS

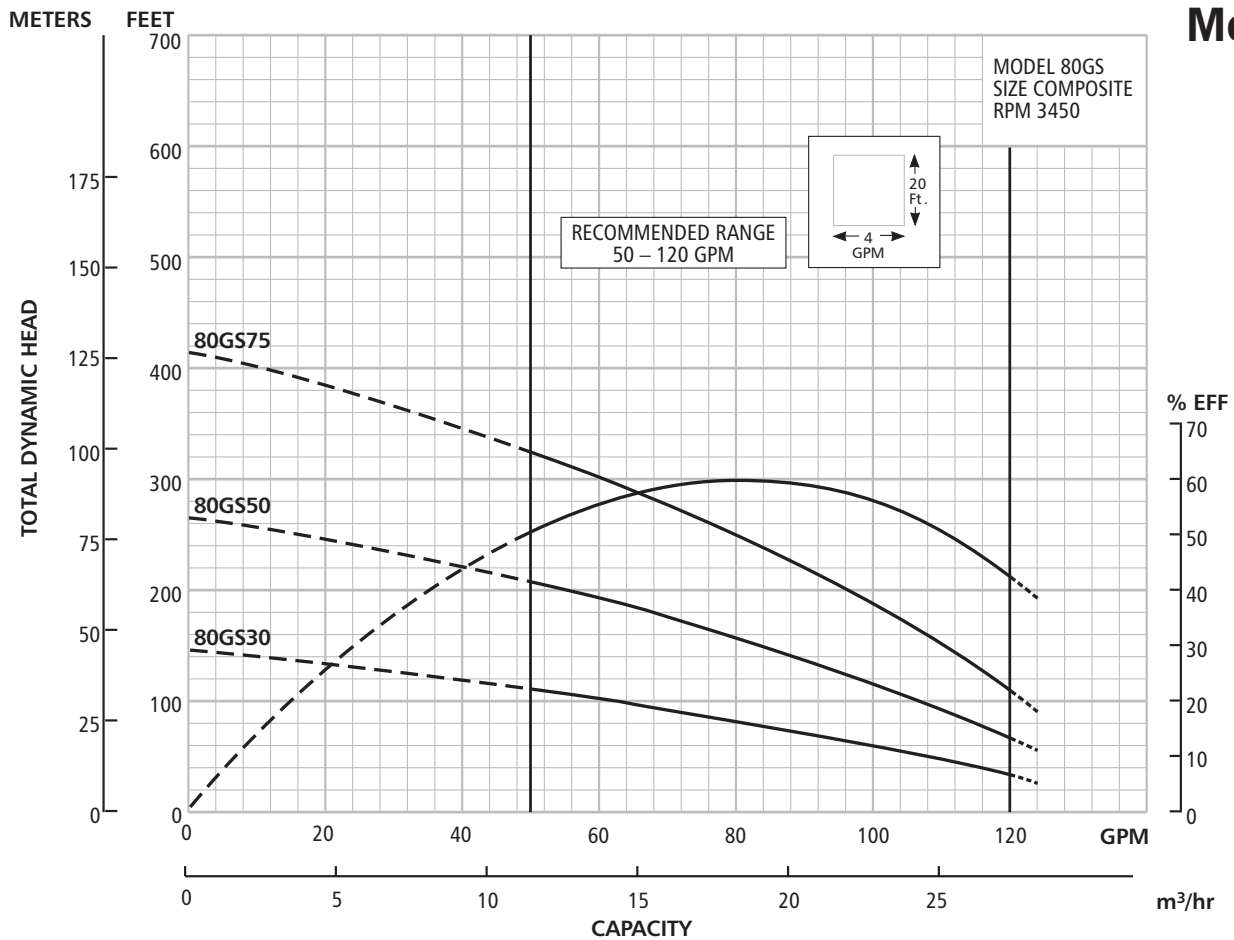



**ITT**  
**2881 East Bayard Street, Seneca Falls, NY 13148**  
**Phone: (315) 568-7123 • Fax: (315) 568-7973**  
**[www.goulds.com](http://www.goulds.com)**

Goulds Pumps is a registered trademark of ITT Corporation. ITT, the Engineered Blocks Symbol and Engineered for Life are registered trademarks of ITT Manufacturing Enterprises, Inc. Noryl and Lexan is a registered trademark of GE Plastic.

Copyright © 2010 ITT Corporation B33-80GS May, 2010 Printed in U.S.A.  
SPECIFICATIONS ARE SUBJECT TO CHANGE WITHOUT NOTICE.

