

# Performance Data

HE8/HE12/HE20/HE25  
HE30/HE35/HE50

Wholesale Products Page: 6650-1

Section: Performance Data

Dated: June 2007

RPM: **3450**

Discharge: \*

Solids: **1/16"**

## High Head Filtered Effluent Pumps

### 8 GPM

\*Discharge Size 1-1/4" NPT

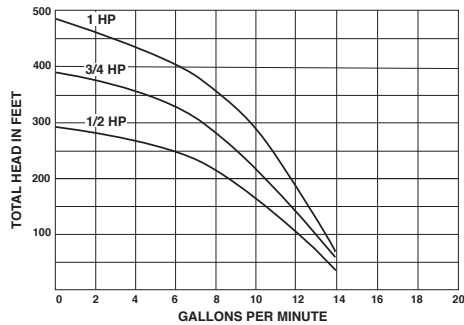

HP	Voltage	Pump Model
1/2	115	HE8-51
1/2	230	HE8-52
3/4	230	HE8-72
1	230	HE8-12

### 25 GPM

\*Discharge Size 2" NPT

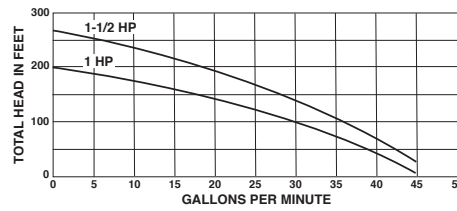

HP	Voltage	Pump Model
1	230	HE25-12
1 1/2	230	HE25-152

### 30 GPM

\*Discharge Size 1-1/4" NPT

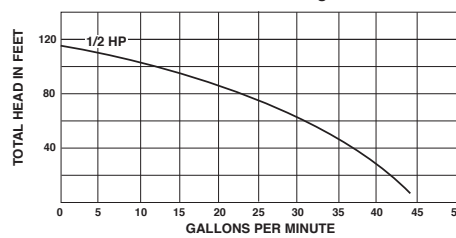

HP	Voltage	Pump Model
1/2	115	HE30-51

### 12 GPM

\*Discharge Size 1-1/4" NPT

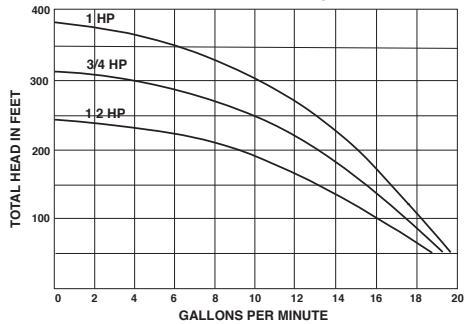

HP	Voltage	Pump Model
1/2	115	HE12-51
1/2	230	HE12-52
3/4	230	HE12-72
1	230	HE12-12

### 35 GPM

\*Discharge Size 2" NPT

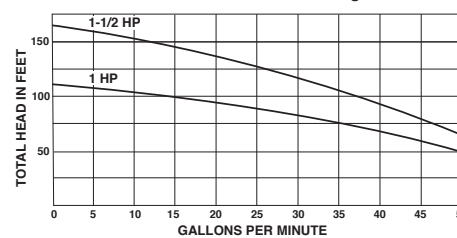

HP	Voltage	Pump Model
1	230	HE35-12
1 1/2	230	HE35-152

### 20 GPM

\*Discharge Size 1-1/4" NPT

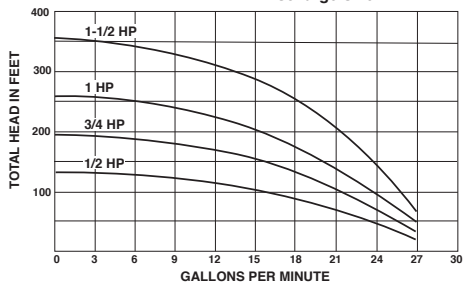

HP	Voltage	Pump Model
1/2	115	HE20-51
1/2	230	HE20-52
3/4	230	HE20-72
1	230	HE20-12
1 1/2	230	HE20-152

### 50 GPM

\*Discharge Size 2" NPT

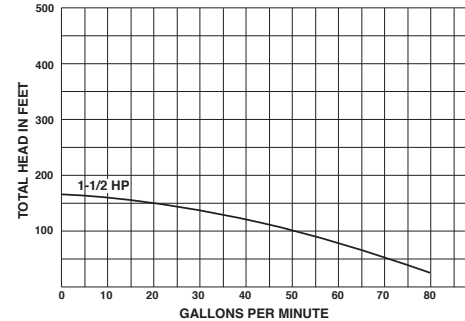

HP	Voltage	Pump Model
1 1/2	230	HE50-152



The curves reflect maximum performance characteristics without exceeding full load (Nameplate) horsepower. All pumps have a service factor of 1.2. Operation is recommended in the bounded area with operational point within the curve limit. Performance curves are based on actual tests with clear water at 70° F. and 1280 feet site elevation.

Conditions of Service:

GPM: \_\_\_\_\_ TDH: \_\_\_\_\_

## High Head Filtered Effluent Pumps

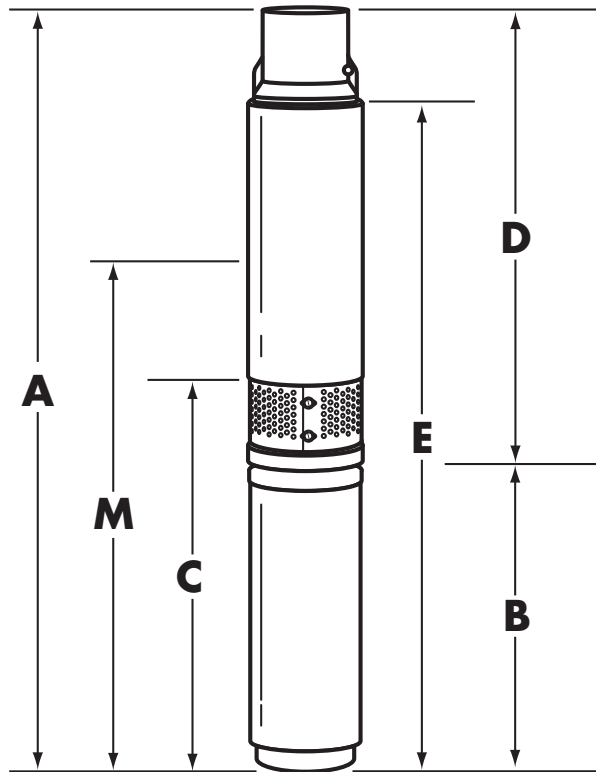

- A = Overall Pump Height
- B = Motor Height
- C = Intake Height
- D = Pump End Height
- E = Bypass Orifice Height
- M = Minimum Liquid Level
- Discharge = Discharge Size (NPT)

MODEL	A	B	C	D	E	M	DISCHARGE
HE8-51	24-1/4"	9-1/2"	12"	14-3/4"	20-3/4"	19-1/2"	1-1/4"
HE8-52	24-1/4"	9-1/2"	12"	14-3/4"	20-3/4"	19-1/2"	1-1/4"
HE8-72	26"	10-1/2"	13"	15-1/2"	22-1/2"	21"	1-1/4"
HE8-12	29-3/4"	11-3/4"	14-1/4"	18"	26-1/4"	23"	1-1/4"
HE12-51	23-1/4"	9-1/2"	12"	13-3/4"	19-3/4"	20"	1-1/4"
HE12-52	23-1/4"	9-1/2"	12"	13-3/4"	19-3/4"	20"	1-1/4"
HE12-72	26-1/4"	10-1/2"	13"	15-3/4"	22-3/4"	21-1/2"	1-1/4"
HE12-12	29"	11-3/4"	14-1/4"	17-1/4"	25-1/2"	23-1/2"	1-1/4"
HE20-51	23-1/2"	9-1/2"	12"	14"	20"	20"	1-1/4"
HE20-52	23-1/2"	9-1/2"	12"	14"	20"	20"	1-1/4"
HE20-72	25-1/2"	10-1/2"	13"	15"	22"	22"	1-1/4"
HE20-12	27-1/2"	11-3/4"	14-1/4"	15-3/4"	24"	26"	1-1/4"
HE20-152	34-1/4"	15-1/4"	17-3/4"	19"	30-3/4"	27"	1-1/4"
HE30-51	23-1/2"	9-1/2"	12"	14"	20-1/2"	20"	1-1/4"
HE25-12	29-3/4"	11-3/4"	14-1/4"	18"	28"	27"	2"
HE25-152	36-1/4"	15-1/4"	17-3/4"	21"	34-1/2"	29"	2"
HE35-12	26-1/4"	11-3/4"	14-1/4"	14-1/2"	24-1/2"	27"	2"
HE35-152	33-3/4"	15-1/4"	17-3/4"	18-1/2"	32"	29"	2"
HE50-152	34"	15-1/4"	17-3/4"	21"	32-1/4"	29"	2"

All dimensions in inches. Metric for international use. Component dimensions may vary  $\pm 1/8$  inch. Dimensional data not for construction purpose unless certified. Dimensions and weights are approximate. On/Off level adjustable. We reserve the right to make revisions to our product (s) and the product (s) specifications without notice.

**MODEL: HE8/HE12/HE20/HE25/HE30/HE35/HE50  
High Head Filtered Effluent Pumps**

<b>R.P.M.</b>	3450
<b>MOTOR PROTECTION</b>	BUILT IN OVERLOAD AND SURGE PROTECTION

HP	VOLTAGE	PHASE	NEC CODE	SERVICE FACTOR	FULL LOAD AMPS
1/2	115	1	-	1	10.5
1/2	230	1	-	1	6
3/4	230	1	-	1	8
1	230	1	-	1	9.8
1-1/2	230	1	-	1	13.1



**MODEL: HE8/HE12/HE20/HE25/HE30/HE35/HE50  
High Head Filtered Effluent Pumps****Physical Data:**

DISCHARGE SIZE (NPT)	(1-1/4" on 8, 12, 20, and 30 GPM pumps) ( 2" on 25 and 35 GPM pumps)
SOLIDS SIZE	1/16" Diameter
IMPELLER TYPE	
CABLE LENGTH	20' STANDARD 30' OPTIONAL
PAINT	

**Temperature:**

MAXIMUM LIQUID	122°F
MAXIMUM STATOR	
OIL FLASH POINT	

**Technical Data:**

POWER CORD TYPE	SJTW, STW-A	
MATERIALS OF CONSTRUCTION	MOTOR HOUSING	STAINLESS STEEL
	CASING	STAINLESS STEEL
	IMPELLER	THERMOPLASTIC
	MOTOR SHAFT	
	HARDWARE	STAINLESS STEEL
	"O" RINGS	
MECHANICAL SEALS Standard:		
UPPER BEARING		
LOWER BEARING		

## **MODEL: HE8/HE12/HE20/HE25/HE30/HE35/HE50 High Head Filtered Effluent Pumps**

### **1.01 GENERAL**

Contractor shall furnish all labor, materials, equipment and incidentals required to provide (Qty.) submersible centrifugal effluent pump(s) as specified herein. The pump models covered in this specification are the HE8, HE12, HE20, HE25, HE30, HE35 and HE50. The pump furnished for this application shall be MODEL \_\_\_\_\_ as manufactured by Hydromatic Pumps.

### **2.01 DESIGN CONDITIONS**

Each pump shall be rated \_\_\_\_\_ H.P., \_\_\_\_\_ volts, \_\_\_\_\_ phase, \_\_\_\_\_ hertz and operate at \_\_\_\_\_ RPM.

### **3.01 OPERATING CONDITIONS**

The pump shall deliver \_\_\_\_\_ U.S. GPM/LPS at \_\_\_\_\_ feet/meters TDH, and handle a \_\_\_\_\_ inch solid. The curve submitted for approval shall state, in addition to head and capacity performance, solid handling capability, amp rating, and design impeller diameter.

### **4.01 CONSTRUCTION**

Each pump shall be of the sealed submersible type, incorporating features normally found in pumps furnished for the residential market.

These features include:

1. The seal housing for the HE8, HE12, HE20, HE25, HE30, HE35 and HE50 is corrosion resistant stainless steel.
2. The pump inlet shall be double screened.
3. All power cords shall be water resistant UL or CSA approved.

### **5.01 MOTOR AND SHAFT**

The stator, rotor and bearings shall be mounted in a sealed submersible type housing. Single phase motors shall be split phase or capacitor start with centrifugal switch. Three phase motors shall be Polyphase. Full Load and Locked Rotor Amps as well as Start and Run winding resistance shall be tabulated for each pump.

### **6.01 IMPELLER**

The Impeller shall be thermoplastic construction.

### **7.01 MANUAL CONTROL**

The Single Phase pumps are not supplied with any type of automatic control.

### **8.01 TESTING**

All pumps shall be individually tested to include the following:

1. The pump and power cord shall be visually inspected for imperfections, cuts or nicks.
2. The pump shall have a ground continuity check and the motor chamber shall be Hi-potted to test for moisture content and/or insulation defects.

**THIS PAGE LEFT INTENTIONALLY BLANK**