

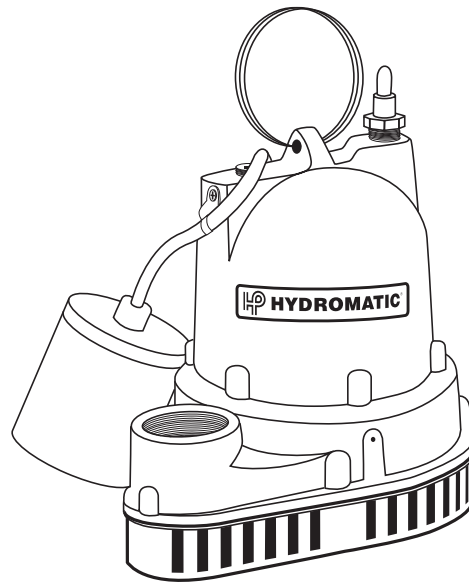

# HYDROMATIC®

## W/D/V-A1

**Submersible  
Sump Pump**



**W-A1**

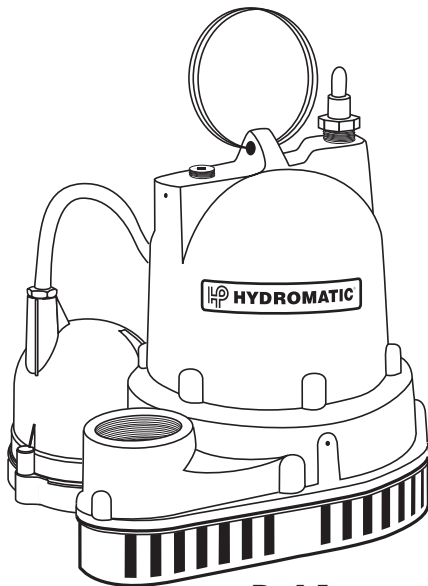

**D-A1**

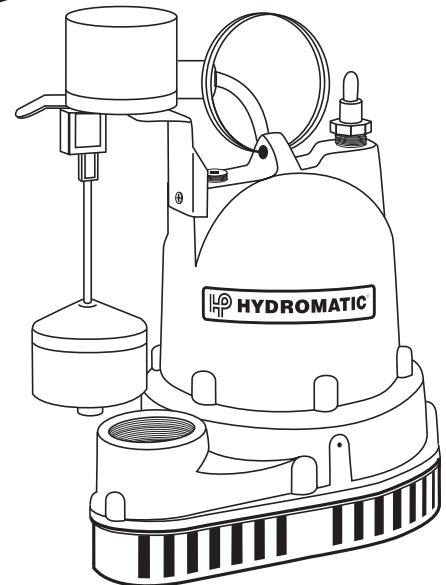

**V-A1**

NOTE! To the installer: Please make sure you provide this manual to the owner of the pumping equipment or to the responsible party who maintains the system.



**Pentair  
Water™**

## General Information

Thank you for purchasing your HYDROMATIC pump. To help ensure years of trouble-free operation, please read the following manual carefully.

### Before Operation:

Read the following instructions carefully. Reasonable care and safe methods should be practiced. Check local codes and requirements before installation.

### Attention:

This manual contains important information for the safe use of this product. Read this manual completely before using this product and refer to it often for continued safe product use. **DO NOT THROW AWAY OR LOSE THIS MANUAL.** Keep it in a safe place so that you may refer to it often.

**WARNING: Before handling these pumps and controls, always disconnect the power first. Do not smoke or use sparkable electrical devices or flames in a septic (gaseous) or possible septic sump.**

## Pump Warning

**To reduce risk of electrical shock:**

### Risk of Electrical Shock:

This pump has not been investigated for use in swimming pool areas.

1. This pump is supplied with a grounding conductor and grounding-type attachment plug. To reduce risk of electrical shock, be certain that it is connected only to a properly grounded, grounding-type receptacle.
2. Septic tank is to be vented in accordance with local plumbing codes.
3. Do not smoke or use sparkable electrical devices or flame in a septic (gaseous) or possible septic sump.
4. A septic sump condition may exist and if entry into sump is necessary, then (1) provide proper safety precautions per OSHA requirements and (2) do not enter sump until these precautions are strictly adhered to.
5. Do not install pump in location classified as hazardous per N.E.C., ANSI/NFPA 70 - 2001. Failure to heed above cautions could result in injury or death.
6. Make sure float (automatic models) hangs free. It should not come into contact with side or bottom of sump pit.
7. Make sure sump is free of string, cloth, nails, gravel, etc. before installing pump.
8. Do not set pump directly on the bottom of sump if it is not solid. Raise the pump by placing bricks or concrete blocks underneath it.
9. Use steel or plastic pipe for all connecting lines between pump and sewer outlet.  
Note: Some city regulations do not allow installing a pump with plastic pipe. Check local regulations.
10. Hydromatic check valve should be installed in discharge pipe, at least twelve inches above the discharge outlet of the pump.
11. Connect to power source using 3-prong grounded 115/230 volt AC receptacle. Do not remove ground pin from electrical plug. Do not use an extension cord.
12. For proper automatic operation make sure the pump power cord is plugged into the back of the "piggyback" receptacle on the switch cord.
13. Use pump submerged for pumping waterlike liquids (temperature to 120° F).

**CAUTION: Do not pump flammable liquids, strong chemicals or salt water.**

14. In applications where the pump may sit idle for months at a time, it is recommended that the pump(s) be cycled every few months to ensure the pumping system is working properly when needed.
15. An audible alarm, such as the Hydromatic Q-Alert for high water conditions,

## Pump Installation

These important instructions must be followed for satisfactory performance of your pump. Before installation, check your local electrical and plumbing codes.

1. Provide proper sump

### Minimum Sump Diameter

W-A1 18"

D-A1 12"

V-A1 12"

### Approx. Turn-On Level

W-A1 9-1/2"

D-A1 10"

V-A1 7-7/8"

### Approx. Turn-Off Level

W-A1 3-1/2"

D-A1 4"

V-A1 3-3/8"

should be installed for additional protection against high water conditions.

**NOTE: The Q-Alert alarm panel is for indoor use only. For applications and product information, contact your HYDROMATIC distributor.**

**Your pump warranty is void...**

If . . . power cord has been cut.

If . . . pump has been used to pump mud, cement, tar, abrasives or chemicals.

If . . . pump has been used for pumping of hot water (above 120° F).

If . . . pump has been dismantled by other than authorized Hydromatic service center or distributor.

# Installation Drawings

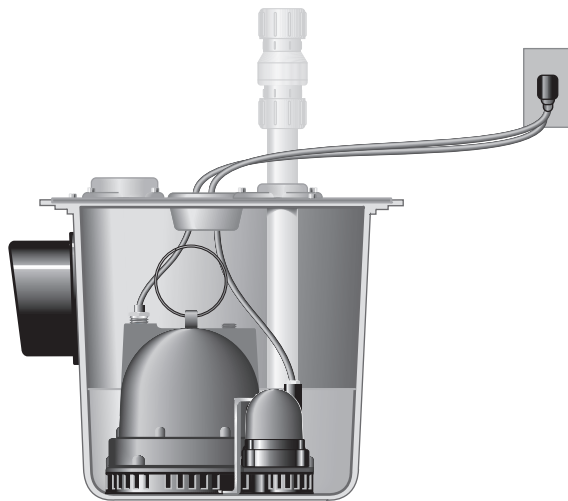

**D-A1**



**W-A1**

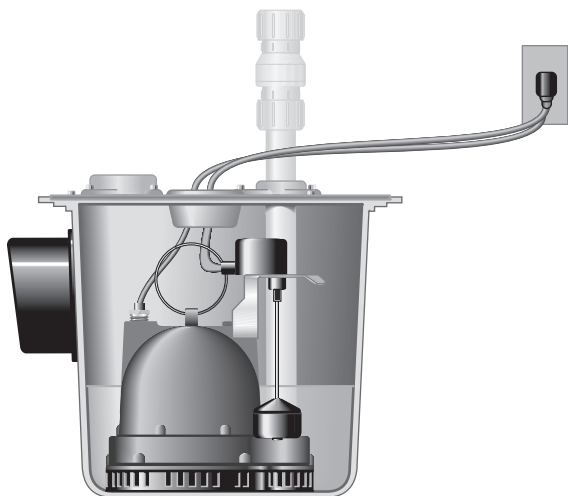

**V-A1**

# Pump Servicing

Servicing should be performed only by an authorized Hydromatic service center.

**WARNING: Always disconnect the pump from power source before handling or making any adjustments. Always wear rubber boots when there is water on the floor and you must unplug the pump or make any adjustments.**

**NOTE: Automatic thermal overload protects the sealed-in-oil motor. Running dry may overheat the motor and activate the overload protector until the unit cools.**

## Pump does not run or just hums.

1. Line circuit breaker may be off, blown or loose.
2. Water level in sump may be too low to activate automatic float or diaphragm switch.
3. Pump and/or switch cord plug may not be making contact in receptacle.
4. If pump is using the series (piggyback) cord plug, the two plugs may not be plugged tightly together.
5. Float may be stuck. Be sure float operates freely in basin.
6. If the unit is being operated by the optional float control switch, unplug the pump from the piggyback receptacle and plug the pump directly into the power source. If the pump starts each time it is plugged directly into the receptacle and does not start each time

when plugged into the piggy-back switch with the float raised up to a start position, replace the complete piggy-back switch assembly and retest with new assembly.

7. If all symptoms check OK, motor winding may be open; take to authorized service center for check.

## Pump runs but does not deliver water.

1. Check valve may be installed backward. Arrow on valve points in direction of flow.
2. Discharge gate valve, if used, may be closed.
3. Pump may be air locked. Start and stop several times by plugging and unplugging cord. Check vent hole in pump case for plugging.

HYDROMATIC pumps have a small air vent hole in the impeller cavity to let out trapped air. If this hole becomes plugged, pump may air lock. To break the air lock, use a small screwdriver to clear hole in the impeller cavity.

As a secondary precaution in installations of this type — 1/16" hole should be drilled in the discharge pipe below the check valve. The check valve should be 12 to 18 inches above pump discharge. Do not put check valve directly into pump discharge opening.

## NOTE: In sumps where the pump is operating daily, air locking rarely occurs.

4. Pump head may be too high. Pump cannot deliver water over 25' vertical lift. Horizontal distance does not affect pumping, except for friction loss through the pipe.
5. Inlet in pump base may be clogged. Remove pump and clean out openings.
6. Impeller or volute openings may be plugged or partially plugged. Remove pump and clean out.

## Pump runs and pumps out sump but does not stop.

1. Float is stuck in up position. Be sure float is not hung up and operates freely in basin.
2. Switch contacts may be stuck; replace switch.

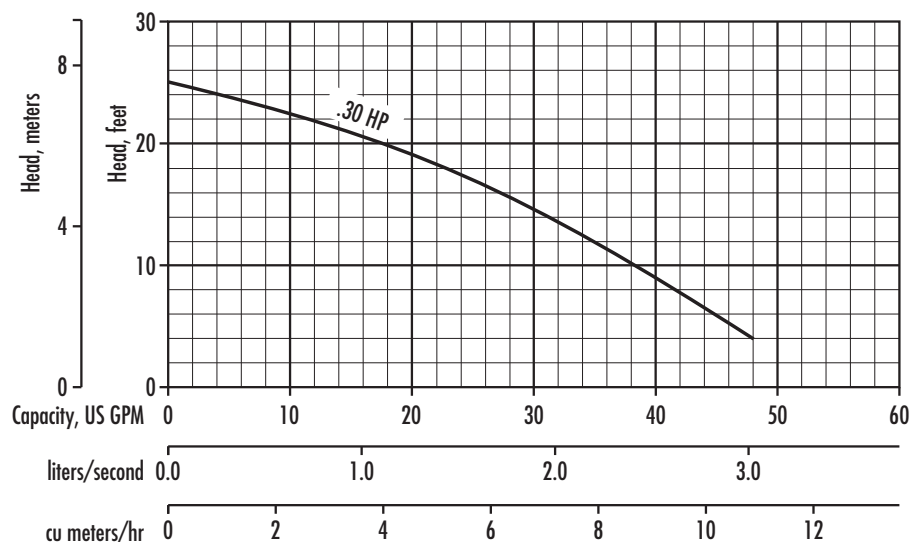

**Pump runs but delivers only small amount of water.**

1. Pump may be air locked. Start and stop several times by plugging and unplugging cord. Check vent hole in pump case for plugging.
2. Pump head may be too high. Pump cannot deliver water over 25' vertical lift. Horizontal distance does not affect pumping, except loss due to friction through discharge pipe.
3. Inlet in pump base may be clogged. Remove pump and clean out openings.
4. Impeller or volute openings may be plugged or partially plugged. Remove pump and clean out.
5. Pump impeller may be partially clogged causing

motor to run slow, resulting in motor overload. Clear impeller.

**Fuse blows or circuit breaker trips when pump starts.**

1. Inlet in pump base may be clogged. Remove pump and clean out openings.
2. Impeller or volute openings may be plugged or partially plugged. Remove pump and clean out.
3. Pump impeller may be partially clogged causing motor to run slow, resulting in motor overload. Clear impeller.
4. Fuse size or circuit breaker is too small.
5. Defective motor stator; return to authorized Hydromatic service center for verification.

**Motor runs for short time then stops. Then after short period starts again.**

**Indicates tripping overload caused by symptom shown.**

1. Inlet in pump base may be clogged. Remove pump and clean out openings.
2. Impeller or volute openings may be plugged or partially plugged. Remove pump and clean out.
3. Pump impeller may be partially clogged causing motor to run slow, resulting in motor overload. Clear impeller.
4. Defective motor stator; return to authorized Hydromatic service center.

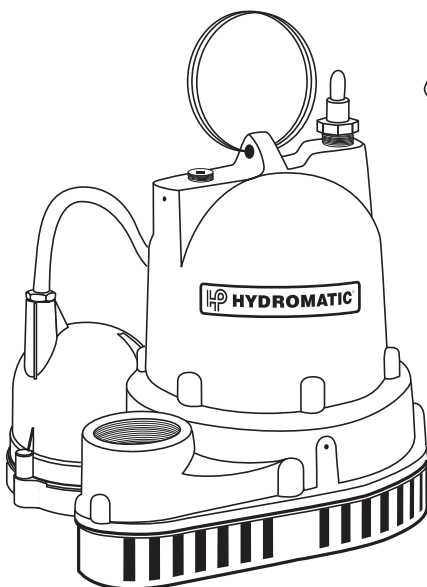

**D-A1**

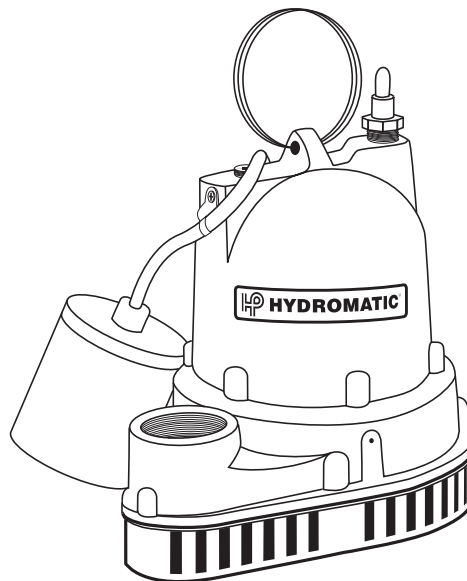

**W-A1**

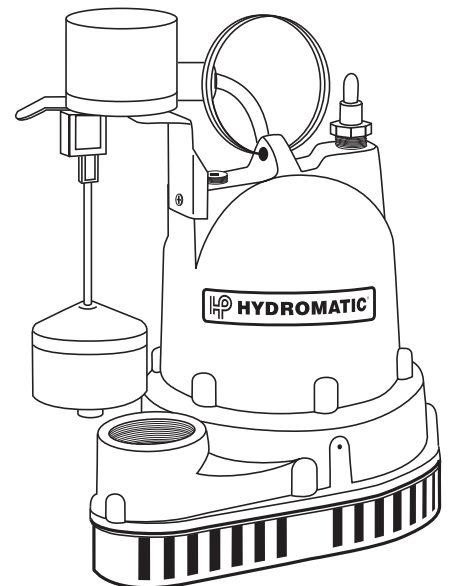

**V-A1**

# Typical Installation

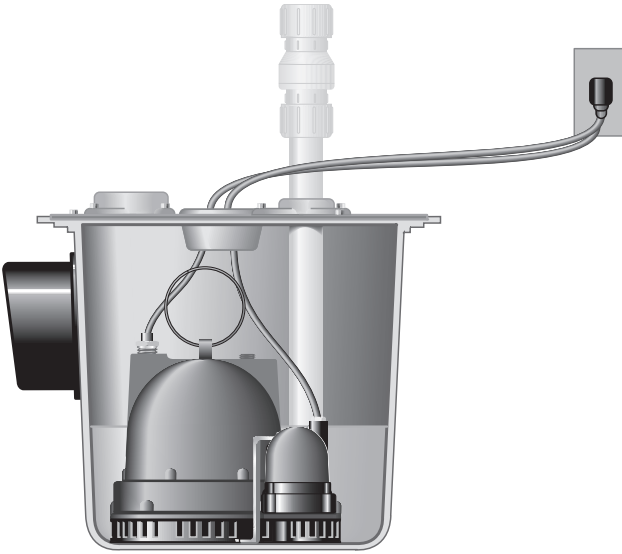

**D-A1**



**W-A1**

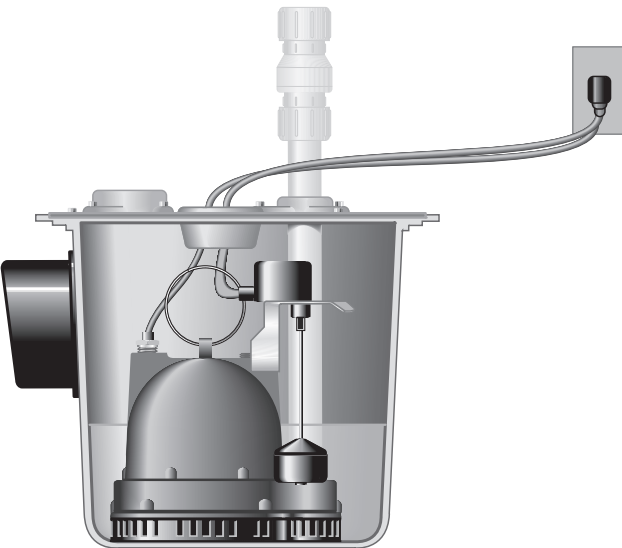

**V-A1**

# W/D/V-A1 Parts List

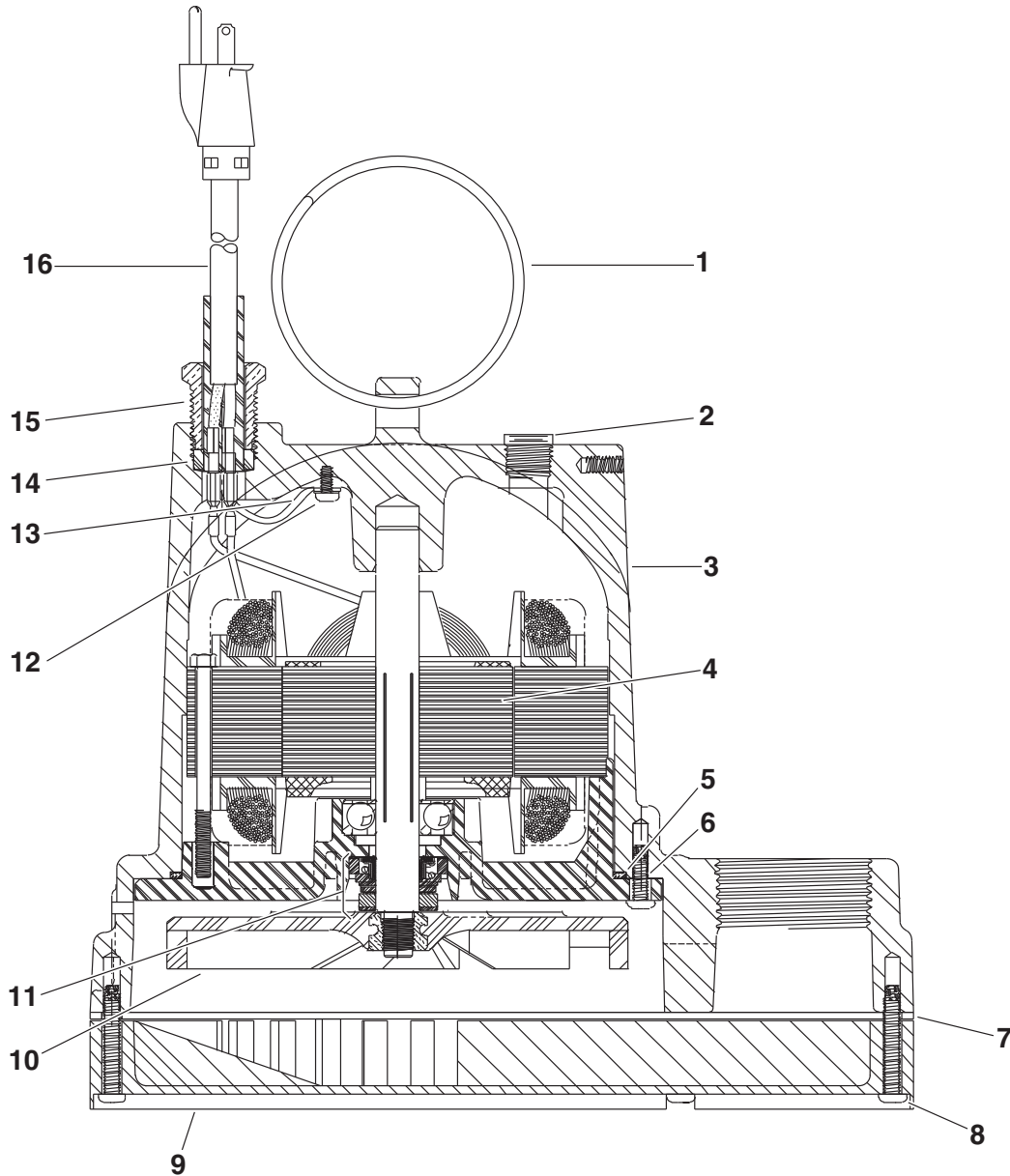

Ref. No.	Part No.	Description	Qty.	Ref. No.	Part No.	Description	Qty.
1	26230A000	Ring Handle	1	14	834-030-1	O-Ring	1
2	14077-000-1	Pipe Plug	1	15	75-005-1	Cord Nut	1
3	*	Motor Housing	1	16	14623-010-1	Power Cord 10'	1
4	*	Stator/Seal Plate/Rotor & Shaft Assembly	1	16	14623-020-1	Power Cord 20'	1
5	139-014-1	Seal Ring	1				
6	14770-005-1	Pan Screw 5	6				
7	8521-101-1	Bottom Plate	1				
8	14770-002-1	Pan Screw 6	5				
9	8520-002-1	Base	1	NOT SHOWN	12150-110-5	FOR AUTOMATIC OPERATION Wide Angle Switch 10'	1
10	8498-003-1	Impeller	1	NOT SHOWN	12150-120-5	Wide Angle Switch 20'	1
11	21607A001	Shaft Seal	1	NOT SHOWN	14974-000-5	Diaphragm Switch 10'	1
12	14770-001-1	Screw	1	NOT SHOWN	14974-001-5	Diaphragm Switch 20'	1
13	6000-053-1	Wire with Terminal	1	NOT SHOWN	13869-510-5	Vertical Switch 10'	1
				NOT SHOWN	13869-520-5	Vertical Switch 20'	1

\*Replace pump

## LIMITED WARRANTY

HYDROMATIC warrants to the original consumer purchaser ("Purchaser" or "You") of HYDROMATIC Sump Pumps, Effluent Pumps, Sewage Pumps (other than 2-1/2"), and Package Systems, that they will be free from defects in material and workmanship for the Warranty Period of 36 months from date of manufacture.

Our warranty will not apply to any product that, in our sole judgement, has been subject to negligence, misapplication, improper installation, or improper maintenance. Without limiting the foregoing, operating a three phase motor with single phase power through a phase converter will void the warranty. Note also that three phase motors must be protected by three-leg, ambient compensated, extra-quick trip overload relays of the recommended size or the warranty is void.

Your only remedy, and HYDROMATIC's only duty, is that HYDROMATIC repair or replace defective products (at HYDROMATIC's choice). You must pay all labor and shipping charges associated with this warranty and must request warranty service through the installing dealer as soon as a problem is discovered. No request for service will be accepted if received after the Warranty Period has expired. This warranty is not transferable.

EXCEPTIONS: Hydromatic Special Application Pumps, Battery Back-Up Sump Pumps, Filtered Effluent Pumps, Grinder Pumps, and 2-1/2" Sewage Pumps are warranted for a period of 12 months from date of purchase or 18 months from date of manufacture, whichever comes first.

HYDROMATIC SHALL NOT BE LIABLE FOR ANY CONSEQUENTIAL, INCIDENTAL, OR CONTINGENT DAMAGES WHATSOEVER.

THE FOREGOING WARRANTIES ARE EXCLUSIVE AND IN LIEU OF ALL OTHER EXPRESS AND IMPLIED WARRANTIES, INCLUDING BUT NOT LIMITED TO THE IMPLIED WARRANTIES OF MERCHANTABILITY AND FITNESS FOR A PARTICULAR PURPOSE. THE FOREGOING WARRANTIES SHALL NOT EXTEND BEYOND THE DURATION EXPRESSLY PROVIDED HEREIN.

Some states do not allow the exclusion or limitation of incidental or consequential damages or limitations on the duration of an implied warranty, so the above limitations or exclusions may not apply to You. This warranty gives You specific legal rights and You may also have other rights which vary from state to state.

This warranty supersedes and replaces all previous warranty publications.

### HYDROMATIC

740 East 9th Street, Ashland, OH 44805

Phone: 888-957-8677 • Fax: 888-840-7867 • Web Site: <http://www.hydromatic.com>



**HYDROMATIC®**  
Pentair Water



- Your Authorized Local Distributor -

#### USA

740 East 9th Street Ashland, Ohio 44805  
Tel: 888-957-8677 Fax: 888-840-7867

[www.hydromatic.com](http://www.hydromatic.com)

#### CANADA

269 Trillium Drive, Kitchener, Ontario, Canada N2G 4W5  
Tel: 519-896-2163 Fax: 519-896-6337