



# self-priming centrifugal pumps



Order suction flange with flapper check separately.

**Some of the fastest priming pumps on the market. Available in high head or medium head series. Features mechanical seals, easy service design, heavy-duty motors, rugged construction. Available in 1 through 5 HP.**

**Optional 6" and 8" Trap Packages are available.**

## APPLICATIONS

- **Lawn Sprinkling...** operate from 1 to 30 or more heads. Can be safely operated by timer or other automatic device.
- **Contractors...** for dewatering excavation, jetting, water transfer and supply operations.
- **Agriculture...** seed bed and plot irrigation, stock watering, fire protection.
- **Industrial...** sump drainage, fire protection, marine pumping, liquid transfer and supply operations.

## D SERIES

### SPECIFICATIONS

**Body and Base** – Close-grained cast iron

**Impeller** – Noryl® on 1 through 2-1/2 HP, bronze on 3 and 5 HP

**Diffuser** – Cast iron

**Shaft** – 1 through 2-1/2 HP: 416 stainless steel; 3 and 5 HP: Carbon steel inside removable shaft sleeve of stainless steel.

### FEATURES

**1 through 5 HP** – Both high head and medium head models offer heavy-duty motors, easy service design, and air volume control tapping.

**Drain Port** – Provided for easy winterizing.

**Medium Head Models** – Deliver up to 115' of head with capacities to 159 GPM.

**High Head Models** – Deliver up to 138' of head with capacities to 162 GPM.

**Easy Serviceability** – Normal wearing parts are easily accessible for service and replacement, without disturbing piping or mounting.

**Heavy-duty Motors** – Designed for continuous operation. Capacitor start, will not cause electrical interference with TV or other appliances. Nationally known motors have ball bearing, stainless steel shaft. For single- and three-phase operation, 3450 RPM.

Noryl® is a registered trademark of General Electric Co.

In order to provide the best products possible, specifications are subject to change.



# self-priming centrifugal pumps

## ORDERING INFORMATION

HIGH HEAD						
Catalog Number	HP	Pipe Tapping Sizes		Motor Voltage	Phase	Approx. Wt. Lbs.
		Suction Flanges	Pump Discharge			
DHE	1	PKG 52	1-1/2"	115/230	1	65
DHE3	1	PKG 52	1-1/2"	208-230/460	3	65
DHF	1-1/2	PKG 52	1-1/2"	115/230	1	72
DHF3	1-1/2	PKG 52	1-1/2"	208-230/460	3	72
DHG	2	PKG 53	2"	115/230	1	113
DHG3	2	PKG 53	2"	208-230/460	3	113
DHHG	2-1/2	PKG 53	2"	115/230	1	120
DHHG3	2-1/2	PKG 53	2"	208-230/460	3	120
DHH	3	PKG 53	1-1/2"	230	1	144
DHH3	3	PKG 53	1-1/2"	208-230/460	3	144
DHJ	5	PKG 72	2"	230	1	184
DHJ3	5	PKG 72	2"	208-230/460	3	184

MEDIUM HEAD						
DMG	2	PKG 52	1-1/2"	115/230	1	86
DMG3	2	PKG 52	1-1/2"	208-230/460	3	86
DMMG	2-1/2	PKG 53	2"	115/230	1	93
DMMG3	2-1/2	PKG 53	2"	208-230/460	3	93
DMH	3	PKG 72	2"	230	1	137
DMH3	3	PKG 72	2"	208-230/460	3	137
DMJ	5	PKG 73	2-1/2"	230	1	184
DMJ3	5	PKG 73	2-1/2"	230/460	3	184

### SUCTION FLANGES (order separately - required for suction tap sizes)

Package 52 -	Package 53 -	Package 72 -	Package 73 -
1-1/2"	2"	2-1/2"	3"

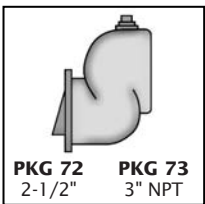
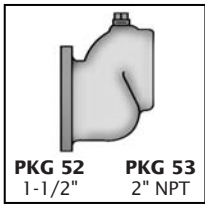

### 6" AND 8" TRAP PACKAGES

Catalog Number	Description	Suction Port Size	Approx. Wt. Lbs.
PKG 51	6" Cast Iron Trap with Basket (For C, CC, and D Series Pumps)	2" NPT	20
PKG 76	Cast Iron Flange for Remote Installation	3" NPT	4
PKG 98	8" Cast Iron Trap with Basket (For C, CC, and D Series Pumps)	3" NPT	40

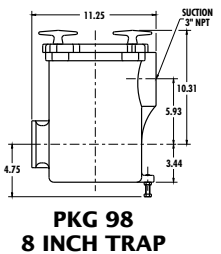
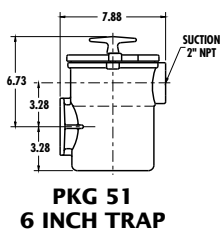
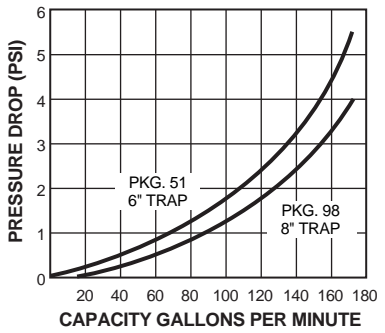



# self-priming centrifugal pumps

## PUMP PERFORMANCE – HIGH HEAD

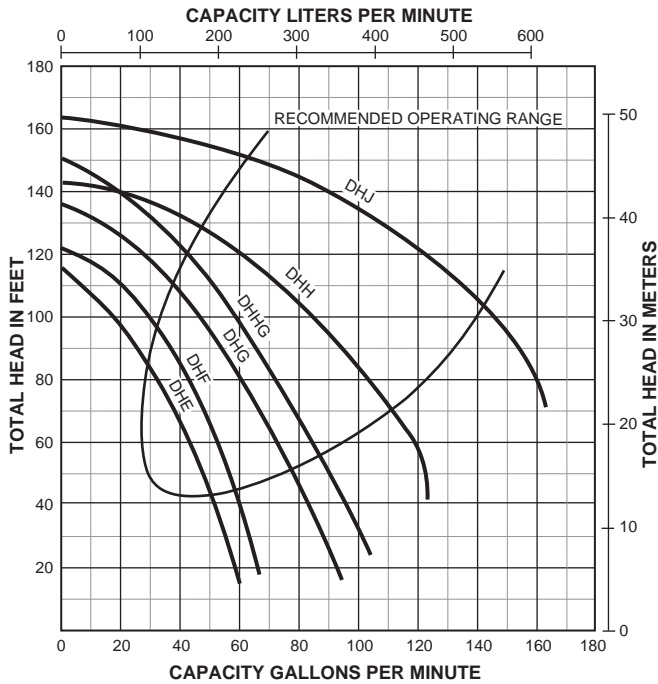

## PUMP PERFORMANCE – MEDIUM HEAD

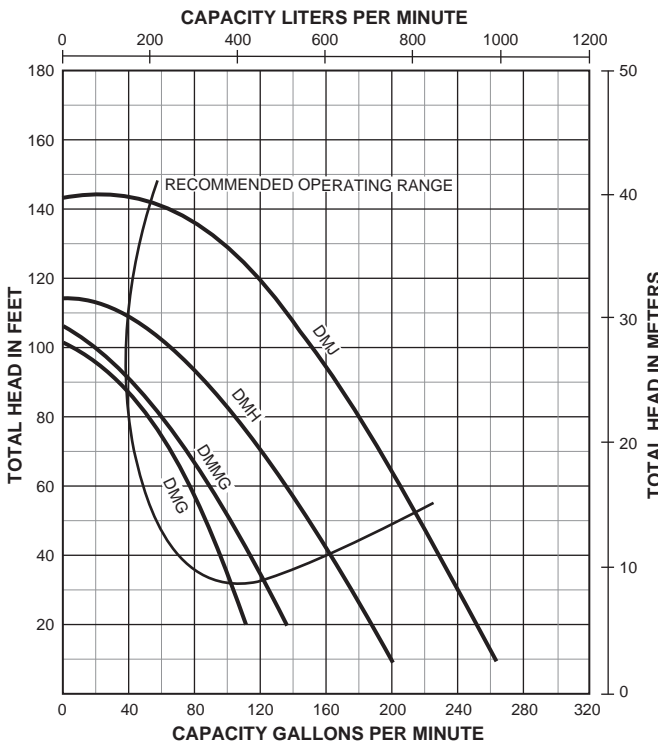

## PUMP PERFORMANCE (Capacity in Gallons Per Minute)

		Discharge		Suction Lift in Feet				
Cat. No.	HP	PSI	Feet Head	5'	10'	15'	20'	25'
				<b>HIGH HEAD</b>				
DHE	1	20	46.2	46	43	41	40	38
		30	69.3	35	32	29	25	21
		40	92.4	19	15	-	-	-
		50	115.5	-	-	-	-	-
		60	138.6	-	-	-	-	-
DHF	1-1/2	20	46.2	55	53	51	49	48
		30	69.3	45	42	39	36	32
		40	92.4	31	27	22	15	-
		50	115.5	-	-	-	-	-
		60	138.6	-	-	-	-	-
DHG	2	20	46.2	77	74	71	68	65
		30	69.3	63	60	56	53	49
		40	92.4	48	44	40	36	30
		50	115.5	30	20	13	-	-
		60	138.6	-	-	-	-	-
DHHG	2-1/2	20	46.2	89	85	82	80	76
		30	69.3	75	72	68	64	60
		40	92.4	60	57	51	49	42
		50	115.5	42	37	31	25	20
		60	138.6	14	-	-	-	-
DHH	3	20	46.2	-	-	-	112	109
		30	69.3	109	103	98	92	89
		40	92.4	90	75	74	69	62
		50	115.5	62	51	42	32	20
		60	138.6	-	-	-	-	-
DHJ	5	20	46.2	-	-	-	-	-
		30	69.3	-	-	-	-	-
		40	92.4	146	141	136	130	122
		50	115.5	122	114	105	99	85
		60	138.6	81	70	50	30	-
<b>MEDIUM HEAD</b>								
DMG	2	20	46.2	84	79	74	69	63
		30	69.3	60	53	46	35	20
		40	92.4	22	-	-	-	-
		50	115.5	-	-	-	-	-
DMMG	2-1/2	20	46.2	103	96	90	80	70
		30	69.3	70	60	50	46	30
		40	92.4	30	18	5	-	-
		50	115.5	-	-	-	-	-
DMH	3	20	46.2	149	140	136	124	119
		30	69.3	116	108	99	85	76
		40	92.4	75	65	51	26	-
DMJ	5	20	46.2	214	209	202	194	182
		30	69.3	185	179	172	165	158
		40	92.4	153	146	139	130	120
		50	115.5	119	107	95	80	50

# self-priming centrifugal pumps

## OUTLINE DIMENSIONS

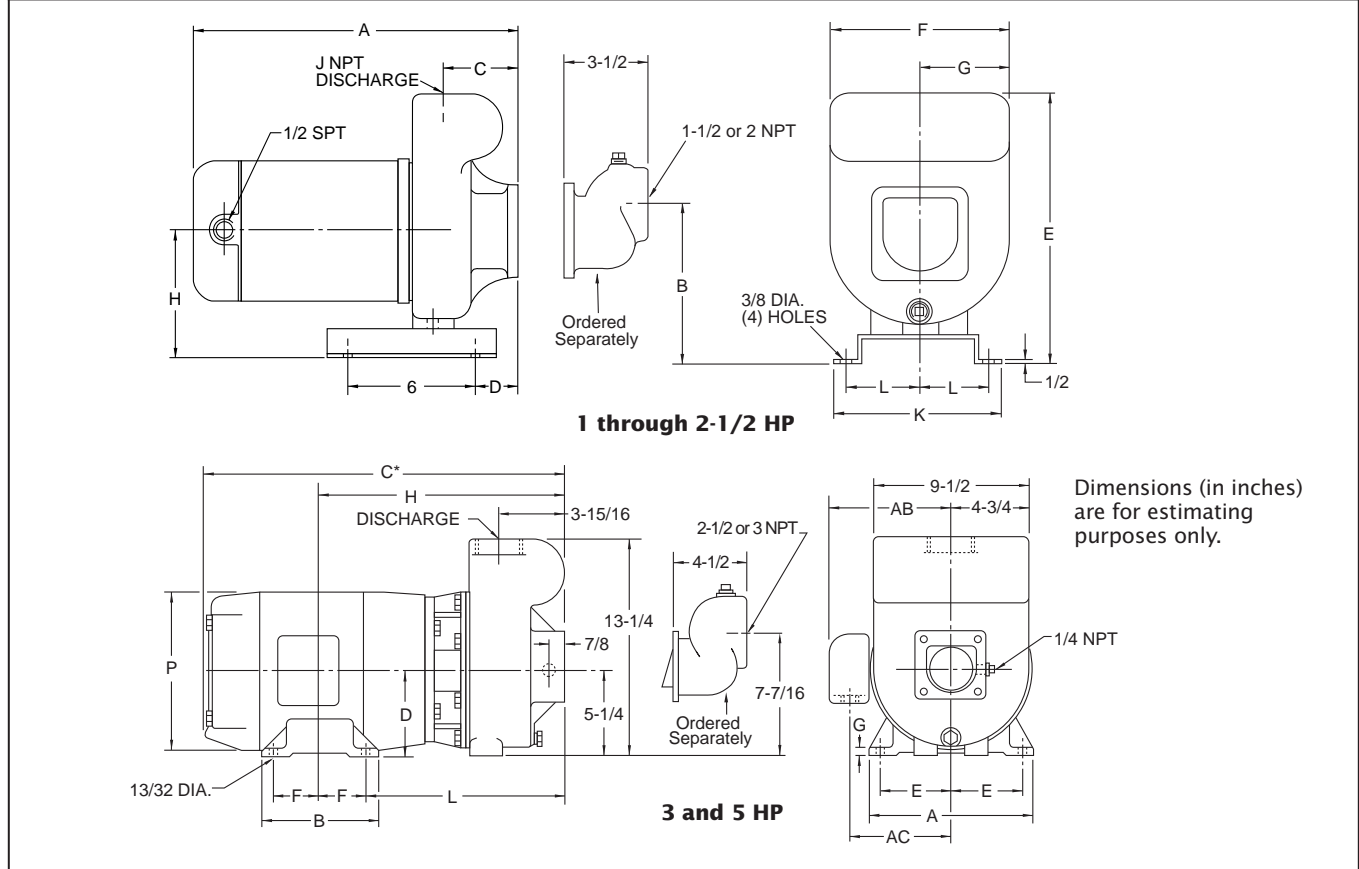

### DIMENSIONS IN INCHES – 1 THROUGH 2-1/2 HP

Catalog Number	HP	A	B	C	D	E	F	G	H	J	K	L
DHE	1	14-13/16	7-1/16	3-1/2	4	11-7/8	7-7/8	3-15/16	5-13/16	1-1/2	7-1/2	3-3/8
DHF	1-1/2	15-11/16	7-1/16	3-1/2	4	11-7/8	7-7/8	3-15/16	5-13/16	1-1/2	7-1/2	3-3/8
DHG	2	17-11/16	7-13/16	3-15/16	3-13/16	14-3/8	9-1/2	4-3/4	6-9/16	2	7-1/2	3-3/8
DHGG	2-1/2	18-11/16	7-13/16	3-15/16	3-13/16	14-3/8	9-1/2	4-3/4	6-9/16	2	7-1/2	3-3/8
DMG	2	16-15/16	7-1/16	3-1/2	4	11-7/8	7-7/8	3-15/16	5-13/16	1-1/2	7-1/2	3-3/8
DMMG	2-1/2	17-15/16	7-1/16	3-1/2	4	11-7/8	7-7/8	3-15/16	5-13/16	2	7-1/2	3-3/8

### DIMENSIONS IN INCHES – 3 AND 5 HP

Catalog Number	HP	A	B	C*	D	E	F	G	H	L	P	AB	AC
DHH	3	9	6	20-3/4	4-1/2	3-3/4	2-1/4	1/2	15	12-3/4	9-3/4	8-1/8	6-1/2
DHJ	5	9	7	21-3/4	4-1/2	3-3/4	2-3/4	1/2	15-1/2	12-3/4	9-3/4	9	7
DMH	3	9	6	20-3/4	4-1/2	3-3/4	2-1/4	1/2	15	12-3/4	9-3/4	8-1/8	6-1/2
DMJ	5	9	7	21-3/4	4-1/2	3-3/4	2-3/4	1/2	15-1/2	12-3/4	9-3/4	9	7

\*Overall length (C) is shown for single-phase motors. Three-phase motors are slightly smaller. Dimensions are for estimating purposes only.